

Synchro TAP

TiN/TiCN-COATED

HSS-PM (Powder Metallurgy) TAP

For High-Speed Tapping on Rigid CNC Machine

**NEW
SIZES**

COLD FORMING TAP

NEW

SYNCHRO TAP with Internal Coolant

- For extreme spindle speeds
- Axial and Radial coolant for reduced heat and longer tool life at higher spindle speeds
- Better chip flow for improved thread finish

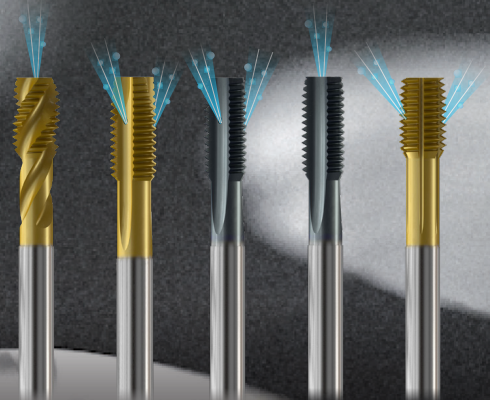

FEATURES OF GEOMETRY

- ▶ **Shorter thread length** will reduce chip problems at higher speed tapping conditions



- ▶ **Shank Tolerance 'h7'** for precision clamping and rigid tapping

- ▶ **More thread relief** allows high speed cutting

- ▶ **HSS-PM (Powder Metallurgy)** for more reliable performance and wear resistance

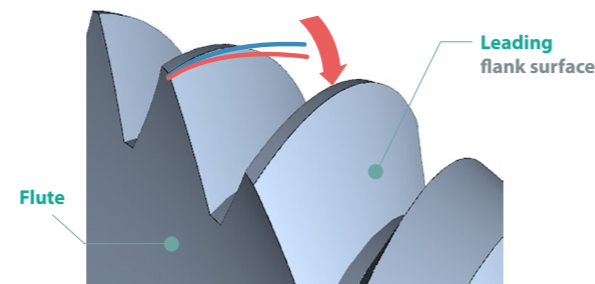

ADVANTAGES

- ▶ **PRODUCTIVITY**
Up to 3 times Faster in tapping compared to conventional taps (General Steel)

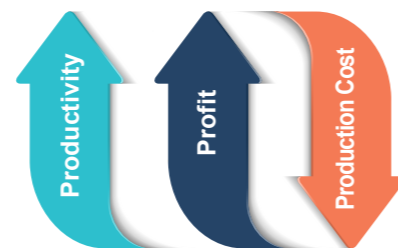

- ▶ **4 kinds of taps are available**

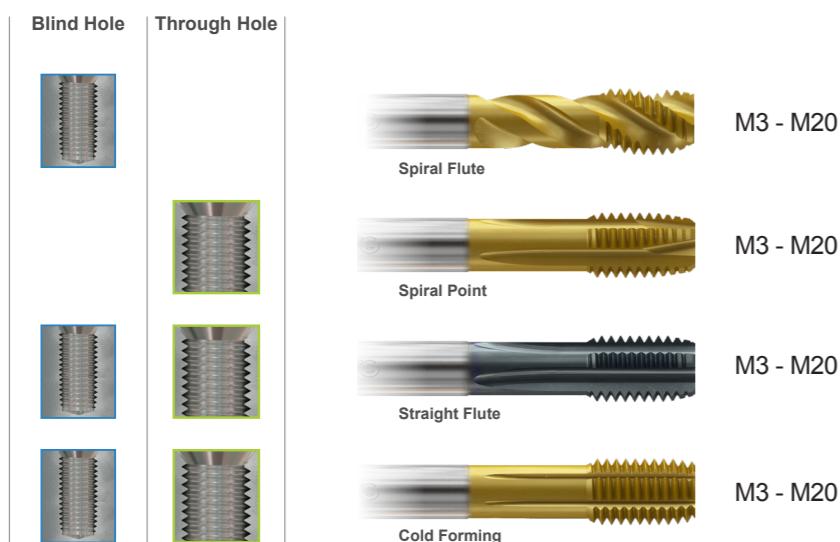

SYNCHRO TAPPING CHUCK (ER TYPE)

- ▶ When using Synchro taps, YG-1 strongly recommends SYNCHRO Tapping Chuck for the best thread quality and superior tool life

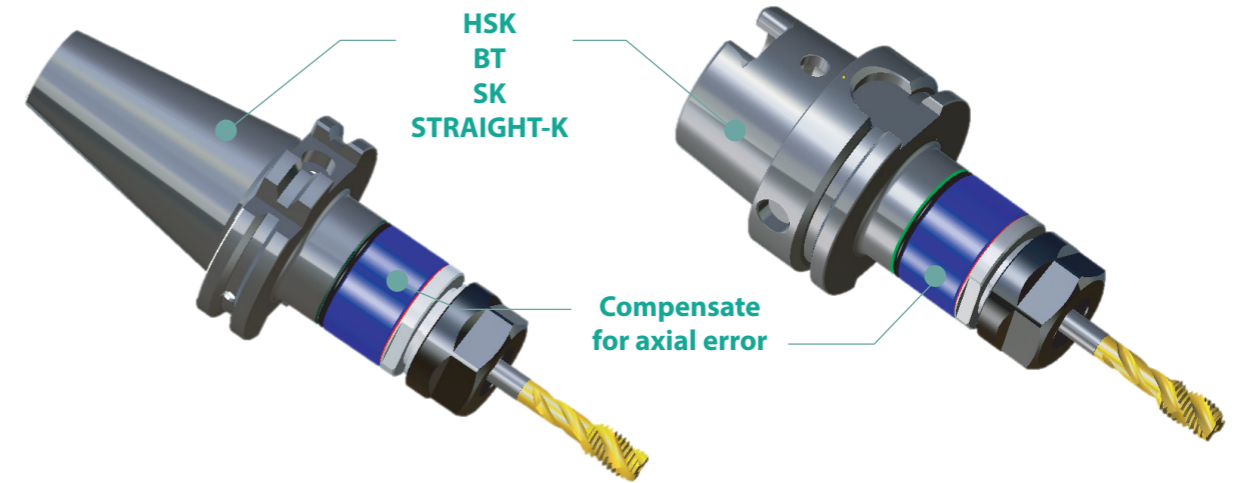

GUIDE TO ICONS

Working Material

GS
Material groups
Steels with good machinability
Rm<850N/mm²

GV
Material groups
Any material with at least
8-10% elongation

GG
Material groups
Grey Cast Iron
and Cast Aluminum

Tool Raw Material

HSS PM

Standard of Tools

DIN 371/376 **DIN 374**
Number of DIN Standard

Class of Thread

6HX

Thread Angle

60°

Helix Angle

R45°

Chamfer Lead

B Form B
(with Spiral point and
Chamfer Lead 4-5 Thread)

C Form C
(Chamfer Lead 2-3 Thread)

E Form E
(Chamfer Lead 1.5-2 Thread)

Surface Treatment

TiCN Titanium Carbon Nitride Coating
TiN Titanium Nitride Coating

Cutting condition

CASE STUDY

TEST I SPIRAL FLUTE TAP (M10x1.5)

Cutting Condition

Tool	Synchro TAP Spiral Flute Tap	Competitor
Size	M10 x 1.5	
Work Material	DIN : C45 / JIS : S45C / AISI : 1045 Hardness : HRC35	
Cutting Speed	30 m/min.	
RPM	955 rev./min.	
Tapping Depth	25.0 mm (2.5xD / Blind Hole)	
Tapping Holes	330	
Cooling Method	External Cooling Water Soluble (9% Emulsion)	
Machine	Vertical Machining Center	

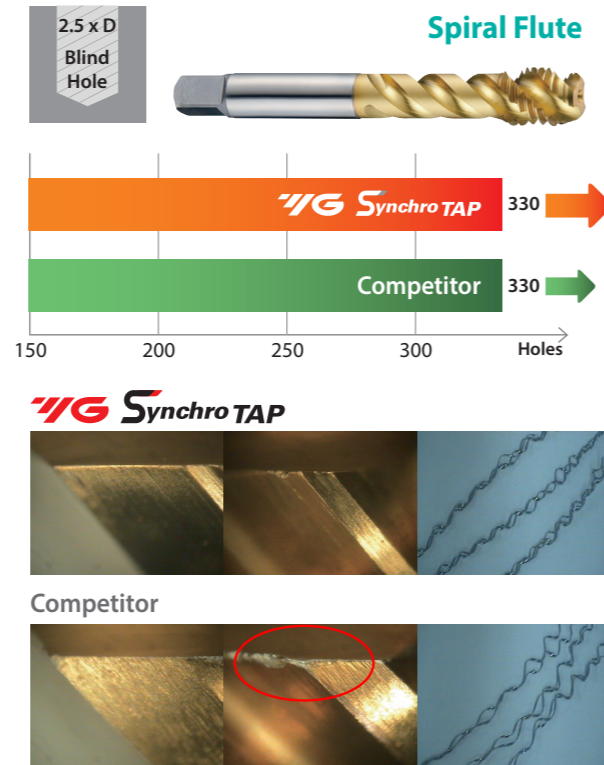

CASE STUDY

TEST III STRAIGHT FLUTE TAP (M10x1.5)

Cutting Condition

Tool	Synchro TAP Straight Flute Tap	Competitor
Size	M10 x 1.5	
Work Material	DIN : 42CrMo4 / JIS : SCM440 / AISI : 4140 Hardness : HRC30	
Cutting Speed	25 m/min.	
RPM	796 rev./min.	
Tapping Depth	20.0 mm (2.0xD / Through Hole)	
Tapping Holes	500	
Cooling Method	External Cooling Water Soluble (9% Emulsion)	
Machine	Vertical Machining Center	

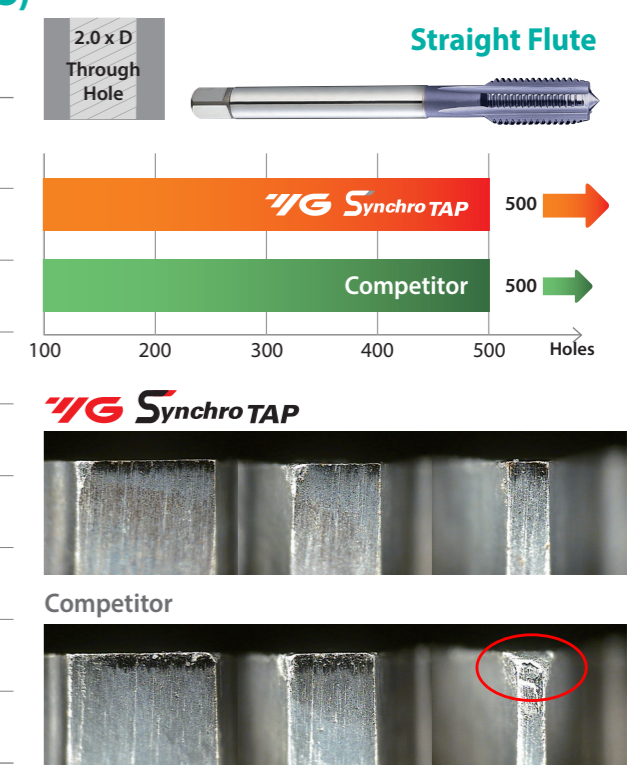

TEST II SPIRAL POINT TAP (M6x1.0)

Cutting Condition

Tool	Synchro TAP Spiral Point Tap	Competitor
Size	M6 x 1.0	
Work Material	DIN : 42CrMo4 / JIS : SCM440 / AISI : 4140 Hardness : HRC30	
Cutting Speed	30 m/min.	
RPM	1592 rev./min.	
Tapping Depth	15.0 mm (2.5xD / Through Hole)	
Tapping Holes	420	
Cooling Method	External Cooling Water Soluble (9% Emulsion)	
Machine	Vertical Machining Center	

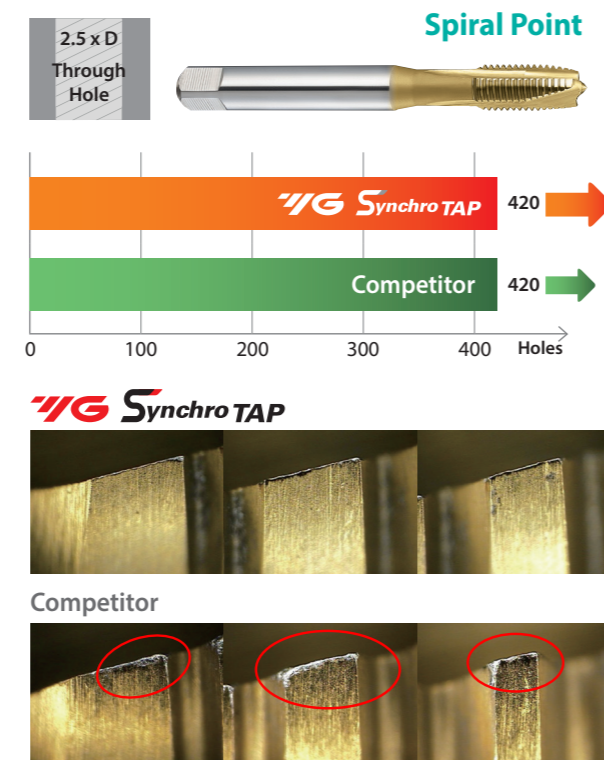

TEST IV COLD FORMING TAP (M6x1.0)

Cutting Condition

Tool	Synchro TAP Cold Forming Tap	Competitor
Size	M6 x 1.0	
Work Material	DIN : C45 / JIS : S45C / AISI : 1045 Hardness : HRC35	
Cutting Speed	35 m/min.	
RPM	1857 rev./min.	
Tapping Depth	15.0 mm (2.5xD / Blind Hole)	
Tapping Holes	960	
Cooling Method	External Cooling Water Soluble (9% Emulsion)	
Machine	Vertical Machining Center	

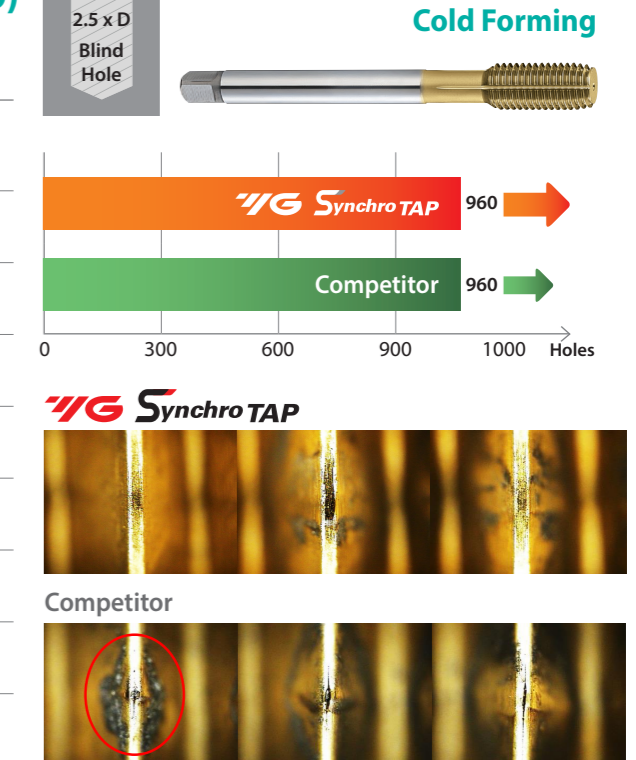

M TIN-COATED HSS-PM SPIRAL FLUTE TAPS
ISO Metric Coarse Threads DIN13

TTS31 SERIES



- ▶ Coated HSS-PM (Powder Metallurgy) Taps for high-speed tapping on rigid CNC machines or equivalent machines
- ▶ Up to 3 times faster in tapping compared to conventional taps
- ▶ For high-speed synchro tapping, synchro holder for increasing tool life and thread quality is recommended
- ▶ High precision threads

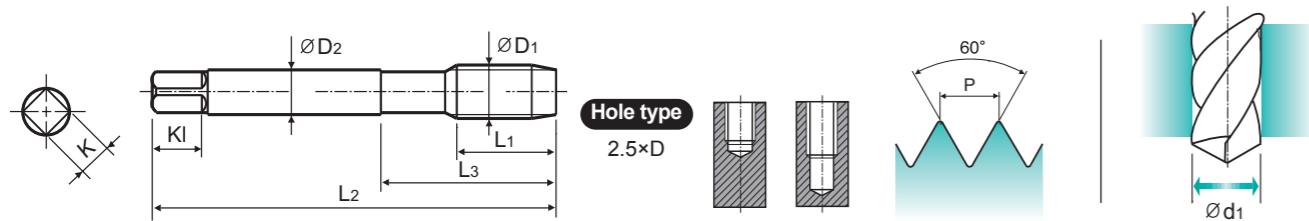

Material groups: **GS** HSS PM DIN 371/376 6HX 60° C R45° TiN p.33

Unit : mm

SIZE	Pitch	EDP No.	Thread Length	Overall Length	Neck Length	Shank Diameter	Square Size	Square Length	No. of Flute	Tapping Drill Diameter
ØD1	P	TiN	L1	L2	L3	ØD2	K	Kl	Z	Ød1
M3 × 0.5		TTS31206	6	56	18	3.5	2.7	6	3	2.5
M4 × 0.7		TTS31246	7	63	21	4.5	3.4	6	3	3.3
M5 × 0.8		TTS31286	8	70	25	6	4.9	8	3	4.2
M6 × 1		TTS31316	10	80	30	6	4.9	8	3	5.0
M8 × 1.25		TTS31366	13	90	35	8	6.2	9	3	6.8
M10 × 1.5		TTS31426	15	100	39	10	8	11	3	8.5
M12 × 1.75		TTS31506	18	110	44	9	7	10	3	10.2
M14 × 2		TTS31546	20	110	44	11	9	12	3	12.0
M16 × 2		TTS31606	20	110	44	12	9	12	3	14.0
M18 × 2.5		TTS31656	25	125	50	14	11	14	4	15.5
M20 × 2.5		TTS31706	25	140	54	16	12	15	4	17.5

- ▶ DIN 371 (M3-M10) and DIN 376 (M12-M20)
- ▶ Coating (TiAIN) is available on your request

◎ : Excellent ○ : Good

ISO	P											M				K						
	Non-alloy steel					Low alloy steel						High alloyed steel, and tool steel				Stainless steel		Grey cast iron		Nodular cast iron		Malleable cast iron
Material Description	1	2	3	4	5	6	7	8	9	10	11	12	13	14	15	16	17	18	19	20		
VDI 3323	1	2	3	4	5	6	7	8	9	10	11	12	13	14	15	16	17	18	19	20		
HRc	13	25	28	32	30	10	29	32	38	15	35	15	23	10	10	26	3	25	21	21		
HB	125	190	250	270	300	180	275	300	350	200	325	200	240	180	180	260	160	250	130	230		
Recommended	◎	◎	◎	◎	◎	◎	◎	◎	◎	◎	◎	◎	◎	◎	◎	◎	◎	◎	◎	◎	◎	

ISO	N								S							H					
	Aluminum-wrought alloy		Aluminum-cast, alloyed			Copper and Copper Alloys (Bronze / Brass)			Non Metallic Materials	Heat Resistant Super Alloys				Titanium Alloys		Hardened steel		Chilled Cast Iron	Hardened Cast Iron		
Material Description	21	22	23	24	25	26	27	28	29	30	31	32	33	34	35	36	37	38	39	40	41
VDI 3323	21	22	23	24	25	26	27	28	29	30	31	32	33	34	35	36	37	38	39	40	41
HRc	60	100	75	90	130	110	90	100			15	30	25	38	34		55	60	42	55	55
HB	60	100	75	90	130	110	90	100			200	280	250	350	320	400Rm	1050Rm	550	630	400	550
Recommended	◎	◎	◎	◎	◎	◎	◎	◎	◎	◎	◎	◎	◎	◎	◎	◎	◎	◎	◎	◎	◎

MF TIN-COATED HSS-PM SPIRAL FLUTE TAPS **NEW**
ISO Metric Fine Threads DIN13

TTS32 SERIES



- ▶ Coated HSS-PM (Powder Metallurgy) Taps for high-speed tapping on rigid CNC machines or equivalent machines
- ▶ Up to 3 times faster in tapping compared to conventional taps
- ▶ For high-speed synchro tapping, synchro holder for increasing tool life and thread quality is recommended
- ▶ High precision threads

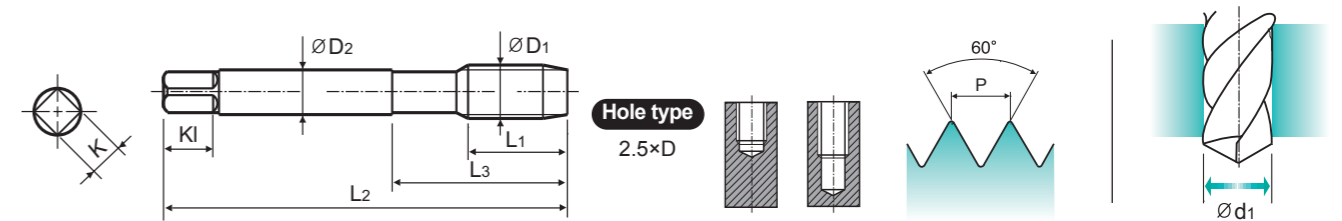

Material groups: **GS** HSS PM DIN 374 6HX 60° C R45° TiN p.33

Unit : mm

SIZE	Pitch	EDP No.	Thread Length	Overall Length	Neck Length	Shank Diameter	Square Size	Square Length	No. of Flute	Tapping Drill Diameter
ØD1	P	TiN	L1	L2	L3	ØD2	K	Kl	Z	Ød1
M8 × 1.0		TTS32376	10	90	36	6	4.9	8	3	7.0
M10 × 1.25		TTS32436	13	100	40	7	5.5	8	3	8.75
M10 × 1.0		TTS32446	10	90	40	7	5.5	8	3	9.0
M12 × 1.25		TTS32526	13	100	40	9	7	10	3	10.75
M12 × 1.5		TTS32516	15	100	40	9	7	10	3	10.5
M14 × 1.5		TTS32556	15	100	40	11	9	12	3	12.5
M16 × 1.5		TTS32616	15	100	40	12	9	12	3	14.5
M18 × 1.5		TTS32676	17	110	44	14	11	14	4	16.5
M20 × 1.5		TTS32726	17	125	50	16	12	15	4	18.5

- ▶ Coating (TiAIN) is available on your request

◎ : Excellent ○ : Good

ISO	P											M				K						
	Non-alloy steel					Low alloy steel						High alloyed steel, and tool steel				Stainless steel		Grey cast iron		Nodular cast iron		Malleable cast iron
Material Description	1	2	3	4	5	6	7	8	9	10	11	12	13	14	15	16	17	18	19	20		
VDI 3323	1	2	3	4	5	6	7	8	9	10	11	12	13	14	15	16	17	18	19	20		
HRc	13	25	28	32	30	10	29	32	38	15	35	15	23	10	10	26	3	25	21	21		
HB	125	190	250	270	300	180	275	300	350	200	325	200	240	180	180	260	160	250	130	230		
Recommended	◎	◎	◎	◎	◎	◎	◎	◎	◎	◎	◎	◎	◎	◎	◎	◎	◎	◎	◎	◎	◎	

ISO	N								S							H					
	Aluminum-wrought alloy		Aluminum-cast, alloyed			Copper and Copper Alloys (Bronze / Brass)			Non Metallic Materials	Heat Resistant Super Alloys				Titanium Alloys		Hardened steel		Chilled Cast Iron	Hardened Cast Iron		
Material Description	21	22	23	24	25	26	27	28	29	30	31	32	33	34	35	36	37	38	39	40	41
VDI 3323	21	22	23	24	25	26	27	28	29	30	31	32	33	34	35	36	37	38	39	40	41
HRc	60	100	75	90	130	110	90	100			15	30	25	38	34		55	60	42	55	55
HB	60	100	75	90	130	110	90	100			200	280	250	350	320	400Rm	1050Rm	550	630	400	550
Recommended	◎	◎	◎	◎	◎	◎	◎	◎	◎	◎	◎	◎	◎	◎	◎	◎	◎	◎	◎	◎	◎

M TIN-COATED HSS-PM SPIRAL POINT TAPS
ISO Metric Coarse Threads DIN13

TTS33 SERIES



- ▶ Coated HSS-PM (Powder Metallurgy) Taps for high-speed tapping on rigid CNC machines or equivalent machines
- ▶ Up to 3 times faster in tapping compared to conventional taps
- ▶ For high-speed synchro tapping, synchro holder for increasing tool life and thread quality is recommended
- ▶ High precision threads

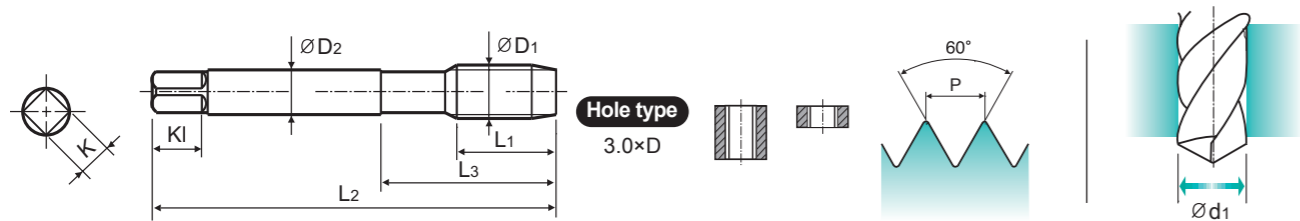

Material groups: **GS** HSS PM DIN 371/376 6HX 60° B TiN p.33

Unit : mm

SIZE	Pitch	EDP No.	Thread Length	Overall Length	Neck Length	Shank Diameter	Square Size	Square Length	No. of Flute	Tapping Drill Diameter
ØD1	P	TiN	L1	L2	L3	ØD2	K	Kl	Z	Ød1
M3	× 0.5	TTS33206	5	56	18	3.5	2.7	6	3	2.5
M4	× 0.7	TTS33246	7	63	21	4.5	3.4	6	3	3.3
M5	× 0.8	TTS33286	8	70	25	6	4.9	8	3	4.2
M6	× 1	TTS33316	10	80	30	6	4.9	8	3	5.0
M8	× 1.25	TTS33366	13	90	35	8	6.2	9	3	6.8
M10	× 1.5	TTS33426	15	100	39	10	8	11	3	8.5
M12	× 1.75	TTS33506	18	110	44	9	7	10	4	10.2
M14	× 2	TTS33546	20	110	44	11	9	12	4	12.0
M16	× 2	TTS33606	20	110	44	12	9	12	4	14.0
M18	× 2.5	TTS33656	25	125	50	14	11	14	4	15.5
M20	× 2.5	TTS33706	25	140	54	16	12	15	4	17.5

- ▶ DIN 371 (M3-M10) and DIN 376 (M12-M20)
- ▶ Coating (TiAIN) is available on your request

◎ : Excellent ○ : Good

ISO	P											M				K				
	Non-alloy steel					Low alloy steel						High alloyed steel, and tool steel		Stainless steel		Grey cast iron		Nodular cast iron		Malleable cast iron
Material Description	1	2	3	4	5	6	7	8	9	10	11	12	13	14	15	16	17	18	19	20
VDI 3323	1	2	3	4	5	6	7	8	9	10	11	12	13	14	15	16	17	18	19	20
HRc	13	25	28	32	30	10	29	32	38	15	35	15	23	10	10	26	3	25	21	21
HB	125	190	250	270	300	180	275	300	350	200	325	200	240	180	180	260	160	250	130	230
Recommended	◎	◎	◎	◎	◎	◎	◎	◎	◎	◎	◎	◎	◎	○	○	◎	◎	◎	◎	◎

ISO	N										S					H					
	Aluminum-wrought alloy		Aluminum-cast, alloyed			Copper and Copper Alloys (Bronze / Brass)					Non Metallic Materials		Heat Resistant Super Alloys			Titanium Alloys		Hardened steel	Chilled Cast Iron	Hardened Cast Iron	
Material Description	21	22	23	24	25	26	27	28	29	30	31	32	33	34	35	36	37	38	39	40	41
VDI 3323	21	22	23	24	25	26	27	28	29	30	31	32	33	34	35	36	37	38	39	40	41
HRc	60	100	75	90	130	110	90	100			15	30	25	38	34		55	60	42	55	55
HB	60	100	75	90	130	110	90	100			200	280	250	350	320	400Rm	1050Rm	550	630	400	550
Recommended			◎	◎	◎	◎	◎	◎													

MF TIN-COATED HSS-PM SPIRAL POINT TAPS **NEW**
ISO Metric Fine Threads DIN13

TTS34 SERIES



- ▶ Coated HSS-PM (Powder Metallurgy) Taps for high-speed tapping on rigid CNC machines or equivalent machines
- ▶ Up to 3 times faster in tapping compared to conventional taps
- ▶ For high-speed synchro tapping, synchro holder for increasing tool life and thread quality is recommended
- ▶ High precision threads

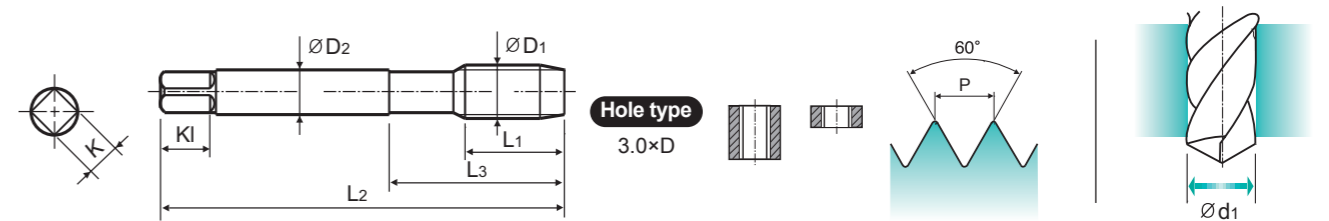

Material groups: **GS** HSS PM DIN 374 6HX 60° B TiN p.33

Unit : mm

SIZE	Pitch	EDP No.	Thread Length	Overall Length	Neck Length	Shank Diameter	Square Size	Square Length	No. of Flute	Tapping Drill Diameter
ØD1	P	TiN	L1	L2	L3	ØD2	K	Kl	Z	Ød1
M8	× 1.0	TTS34376	10	90	36	6	4.9	8	3	7.0
M10	× 1.25	TTS34436	13	100	40	7	5.5	8	3	8.75
M10	× 1.0	TTS34446	10	90	40	7	5.5	8	3	9.0
M12	× 1.5	TTS34516	15	100	40	9	7	10	4	10.5
M12	× 1.25	TTS34526	13	100	40	9	7	10	4	10.75
M14	× 1.5	TTS34556	15	100	40	11	9	12	4	12.5
M16	× 1.5	TTS34616	15	100	40	12	9	12	4	14.5
M18	× 1.5	TTS34676	17	110	44	14	11	14	4	16.5
M20	× 1.5	TTS34726	17	125	50	16	12	15	4	18.5

- ▶ Coating (TiAIN) is available on your request

◎ : Excellent ○ : Good

ISO	P											M				K				
	Non-alloy steel					Low alloy steel						High alloyed steel, and tool steel		Stainless steel		Grey cast iron		Nodular cast iron		Malleable cast iron
Material Description	1	2	3	4	5	6	7	8	9	10	11	12	13	14	15	16	17	18	19	20
VDI 3323	1	2	3	4	5	6	7	8	9	10	11	12	13	14	15	16	17	18	19	20
HRc	13	25	28	32	30	10	29	32	38	15	35	15	23	10	10	26	3	25	21	21
HB	125	190	250	270	300	180	275	300	350	200	325	200	240	180	180	260	160	250	130	230
Recommended	◎	◎	◎	◎	◎	◎	◎	◎	◎	◎	◎	◎	◎	○	○	◎	◎	◎	◎	◎

ISO	N										S					H					
	Aluminum-wrought alloy		Aluminum-cast, alloyed			Copper and Copper Alloys (Bronze / Brass)					Non Metallic Materials		Heat Resistant Super Alloys			Titanium Alloys		Hardened steel	Chilled Cast Iron	Hardened Cast Iron	
Material Description	21	22	23	24	25	26	27	28	29	30	31	32	33	34	35	36	37	38	39	40	41
VDI 3323	21	22	23	24	25	26	27	28	29	30	31	32	33	34	35	36	37	38	39	40	41
HRc	60	100	75	90	130	110	90	100			15	30	25	38	34		55	60	42	55	55
HB	60	100	75	90	130	110	90	100			200	280	250	350	320	400Rm	1050Rm	550	630	400	550
Recommended			◎	◎	◎	◎	◎	◎													

M TiCN-COATED HSS-PM STRAIGHT FLUTE TAPS
ISO Metric Coarse Threads DIN13

TKS35 SERIES



- ▶ Coated HSS-PM (Powder Metallurgy) Taps for high-speed tapping on rigid CNC machines or equivalent machines
- ▶ Up to 3 times faster in tapping compared to conventional taps
- ▶ For high-speed synchro tapping, synchro holder for increasing tool life and thread quality is recommended
- ▶ High precision threads

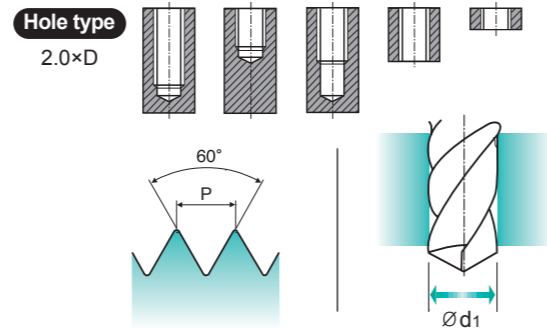
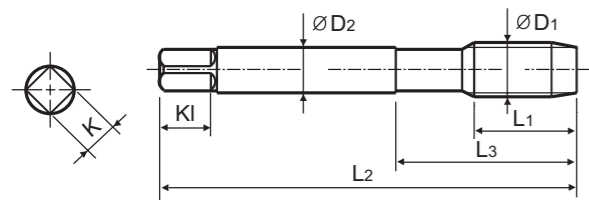

Material groups: **GG** HSS PM DIN 371/376 6HX 60° C TiCN p.33

Unit : mm

SIZE	Pitch	EDP No.	Thread Length	Overall Length	Neck Length	Shank Diameter	Square Size	Square Length	No. of Flute	Tapping Drill Diameter
ØD1	P	TiCN	L1	L2	L3	ØD2	K	KI	Z	Ød1
M3 × 0.5		TKS35206	5	56	18	3.5	2.7	6	3	2.5
M4 × 0.7		TKS35246	7	63	21	4.5	3.4	6	3	3.3
M5 × 0.8		TKS35286	8	70	25	6	4.9	8	3	4.2
M6 × 1		TKS35316	10	80	30	6	4.9	8	3	5.0
M8 × 1.25		TKS35366	13	90	35	8	6.2	9	3	6.8
M10 × 1.5		TKS35426	15	100	39	10	8	11	4	8.5
M12 × 1.75		TKS35506	18	110	44	9	7	10	4	10.2
M14 × 2		TKS35546	20	110	44	11	9	12	4	12.0
M16 × 2		TKS35606	20	110	44	12	9	12	4	14.0
M18 × 2.5		TKS35656	25	125	50	14	11	14	4	15.5
M20 × 2.5		TKS35706	25	140	54	16	12	15	4	17.5

- ▶ DIN 371 (M3-M10) and DIN 376 (M12-M20)
- ▶ Coating (TiAIN) is available on your request

◎ : Excellent ○ : Good

ISO	P											M				K						
	Non-alloy steel					Low alloy steel						High alloyed steel, and tool steel				Stainless steel		Grey cast iron		Nodular cast iron		Malleable cast iron
Material Description	1	2	3	4	5	6	7	8	9	10	11	12	13	14	15	16	17	18	19	20		
VDI 3323	1	2	3	4	5	6	7	8	9	10	11	12	13	14	15	16	17	18	19	20		
HRc	13	25	28	32	30	10	29	32	38	15	35	15	23	10	10	26	3	25	13	21		
HB	125	190	250	270	300	180	275	300	350	200	325	200	240	180	180	260	160	250	130	230		
Recommended	○	○	○	○	○	○	○	○	○	○	○	○	○	○	◎	◎	◎	◎	○	○		

ISO	N					S					H										
	Aluminum-wrought alloy		Aluminum-cast, alloyed			Copper and Copper Alloys (Bronze / Brass)			Non Metallic Materials		Heat Resistant Super Alloys			Titanium Alloys		Hardened steel		Chilled Cast Iron	Hardened Cast Iron		
Material Description	21	22	23	24	25	26	27	28	29	30	31	32	33	34	35	36	37	38	39	40	41
VDI 3323	21	22	23	24	25	26	27	28	29	30	31	32	33	34	35	36	37	38	39	40	41
HRc	60	100	75	90	130	110	90	100			15	30	25	38	34	400Rm	1050Rm	55	60	42	55
HB	60	100	75	90	130	110	90	100			200	280	250	350	320	400Rm	1050Rm	550	630	400	550
Recommended	○	○	○	○	○																

MF TiCN-COATED HSS-PM STRAIGHT FLUTE TAPS **NEW**
ISO Metric Fine Threads DIN13

TKS36 SERIES



- ▶ Coated HSS-PM (Powder Metallurgy) Taps for high-speed tapping on rigid CNC machines or equivalent machines
- ▶ Up to 3 times faster in tapping compared to conventional taps
- ▶ For high-speed synchro tapping, synchro holder for increasing tool life and thread quality is recommended
- ▶ High precision threads

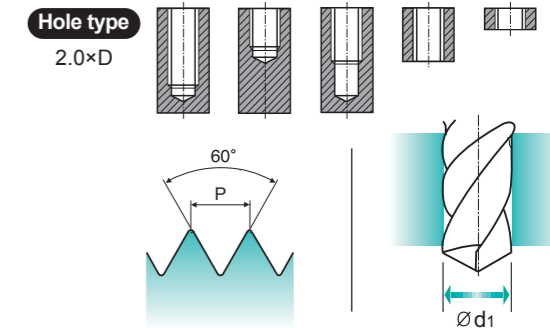
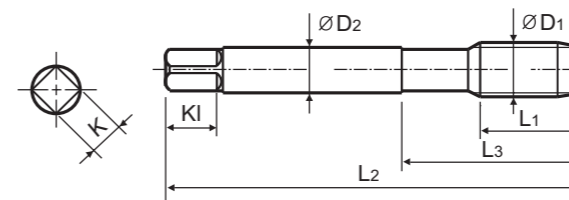

Material groups: **GG** HSS PM DIN 374 6HX 60° C TiCN p.33

Unit : mm

SIZE	Pitch	EDP No.	Thread Length	Overall Length	Neck Length	Shank Diameter	Square Size	Square Length	No. of Flute	Tapping Drill Diameter
ØD1	P	TiCN	L1	L2	L3	ØD2	K	KI	Z	Ød1
M8 × 1.0		TKS36376	10	90	36	6	4.9	8	3	7.0
M10 × 1.25		TKS36436	13	100	40	7	5.5	8	4	8.75
M10 × 1.0		TKS36446	10	90	40	7	5.5	8	4	9.0
M12 × 1.25		TKS36526	13	100	40	9	7	10	4	10.75
M12 × 1.5		TKS36516	15	100	40	9	7	10	4	10.5
M14 × 1.5		TKS36556	15	100	40	11	9	12	4	12.5
M16 × 1.5		TKS36616	15	100	40	12	9	12	4	14.5
M18 × 1.5		TKS36676	17	110	44	14	11	14	4	16.5
M20 × 1.5		TKS36726	17	125	50	16	12	15	4	18.5

- ▶ Coating (TiAIN) is available on your request

◎ : Excellent ○ : Good

ISO	P											M				K						
	Non-alloy steel					Low alloy steel						High alloyed steel, and tool steel				Stainless steel		Grey cast iron		Nodular cast iron		Malleable cast iron
Material Description	1	2	3	4	5	6	7	8	9	10	11	12	13	14	15	16	17	18	19	20		
VDI 3323	1	2	3	4	5	6	7	8	9	10	11	12	13	14	15	16	17	18	19	20		
HRc	13	25	28	32	30	10	29	32	38	15	35	15	23	10	10	26	3	25	13	21		
HB	125	190	250	270	300	180	275	300	350	200	325	200	240	180	180	260	160	250	130	230		
Recommended	○	○	○	○	○	○	○	○	○	○	○	○	○	○	◎	◎	◎	◎	○	○		

ISO	N					S					H										
	Aluminum-wrought alloy		Aluminum-cast, alloyed			Copper and Copper Alloys (Bronze / Brass)			Non Metallic Materials		Heat Resistant Super Alloys			Titanium Alloys		Hardened steel		Chilled Cast Iron	Hardened Cast Iron		
Material Description	21	22	23	24	25	26	27	28	29	30	31	32	33	34	35	36	37	38	39	40	41
VDI 3323	21	22	23	24	25	26	27	28	29	30	31	32	33	34	35	36	37	38	39	40	41
HRc	60	100	75	90	130	110	90	100			15	30	25	38	34	400Rm	1050Rm	55	60	42	55
HB	60	100	75	90	130	110	90	100			200	280	250	350	320	400Rm	1050Rm	550	630	400	550
Recommended	○	○	○	○	○																

M TIN-COATED HSS-PM COLD FORMING TAPS **NEW SIZES**
ISO Metric Coarse Threads DIN13

TTS37 SERIES



- ▶ Coated HSS-PM (Powder Metallurgy) Taps for high-speed tapping on rigid CNC machines or equivalent machines
- ▶ Up to 3 times faster in tapping compared to conventional taps
- ▶ For high-speed synchro tapping, synchro holder for increasing tool life and thread quality is recommended
- ▶ High precision threads

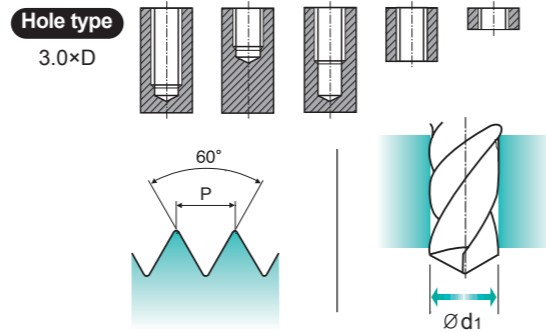
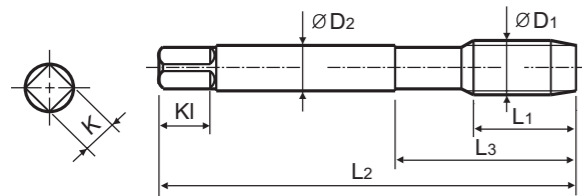

Material groups: **GV** HSS PM DIN 371/376 6HX 60° C TiN p.33

* NEW SIZE

Unit : mm

SIZE	Pitch	EDP No.	Thread Length	Overall Length	Neck Length	Shank Diameter	Square Size	Square Length	Number of Oil Groove	Tapping Drill Diameter
ØD1	P	TiN	L1	L2	L3	ØD2	K	KI	Z	Ød1
M3	× 0.5	TTS37206	5	56	18	3.5	2.7	6	5	2.8
M4	× 0.7	TTS37246	7	63	21	4.5	3.4	6	5	3.7
M5	× 0.8	TTS37286	8	70	25	6	4.9	8	5	4.65
M6	× 1.0	TTS37316	10	80	30	6	4.9	8	5	5.55
M8	× 1.25	TTS37366	13	90	35	8	6.2	9	6	7.4
M10	× 1.5	TTS37426	15	100	39	10	8	11	6	9.3
M12	× 1.75	TTS37506	18	110	44	9	7	10	6	11.2
M14	× 2.0	* TTS37546	20	110	44	11	9	12	8	13.0
M16	× 2.0	* TTS37606	20	110	44	12	9	12	8	15.0
M18	× 2.5	* TTS37656	25	125	50	14	11	14	8	16.8
M20	× 2.5	* TTS37706	25	140	54	16	12	15	8	18.8

- ▶ DIN 371 (M3-M10) and DIN 376 (M12-M20)
- ▶ Coating (TiAIN) is available on your request

◎ : Excellent ○ : Good

ISO	P											M				K					
	Non-alloy steel					Low alloy steel						High alloyed steel, and tool steel		Stainless steel		Grey cast iron		Nodular cast iron		Malleable cast iron	
Material Description	1	2	3	4	5	6	7	8	9	10	11	12	13	14	15	16	17	18	19	20	
VDI 3323	1	2	3	4	5	6	7	8	9	10	11	12	13	14	15	16	17	18	19	20	
HRc	13	25	28	32	30	10	29	32	38	15	35	15	23	10	10	26	3	25	21	21	
HB	125	190	250	270	300	180	275	300	350	200	325	200	240	180	180	275	160	250	130	230	
Recommended	◎	◎	◎	◎	◎	◎	◎	◎	◎	◎	◎	◎	◎	◎	◎	◎	◎	◎	◎	◎	◎

ISO	N										S					H						
	Aluminum-wrought alloy		Aluminum-cast, alloyed			Copper and Copper Alloys (Bronze / Brass)					Non Metallic Materials		Heat Resistant Super Alloys			Titanium Alloys		Hardened steel	Chilled Cast Iron	Hardened Cast Iron		
Material Description	21	22	23	24	25	26	27	28	29	30	31	32	33	34	35	36	37	38	39	40	41	
VDI 3323	21	22	23	24	25	26	27	28	29	30	31	32	33	34	35	36	37	38	39	40	41	
HRc	60	100	75	90	130	110	90	100			15	30	25	38	34		55	60	42	55	55	
HB	60	100	75	90	130	110	90	100			200	280	250	350	320	400Rm	1050Rm	550	630	400	550	
Recommended	◎	◎	◎	◎	◎	◎	◎	◎	◎	◎	◎	◎	◎	◎	◎	◎	◎	◎	◎	◎	◎	◎

MF TIN-COATED HSS-PM COLD FORMING TAPS **NEW**
ISO Metric Fine Threads DIN13

TTS38 SERIES



- ▶ Coated HSS-PM (Powder Metallurgy) Taps for high-speed tapping on rigid CNC machines or equivalent machines
- ▶ Up to 3 times faster in tapping compared to conventional taps
- ▶ For high-speed synchro tapping, synchro holder for increasing tool life and thread quality is recommended
- ▶ High precision threads

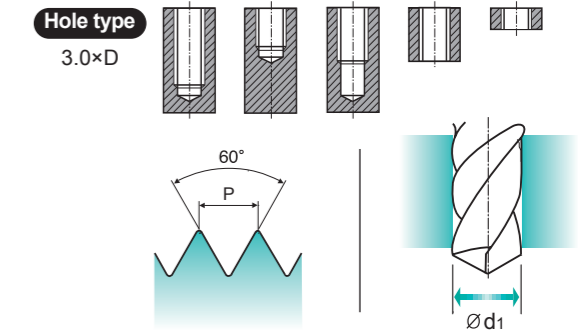
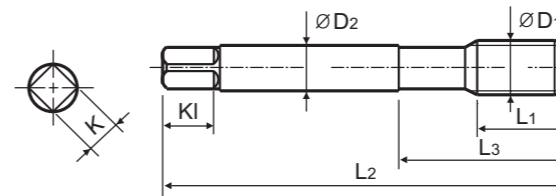

Material groups: **GV** HSS PM DIN 374 6HX 60° C TiN p.33

Unit : mm

SIZE	Pitch	EDP No.	Thread Length	Overall Length	Neck Length	Shank Diameter	Square Size	Square Length	Number of Oil Groove	Tapping Drill Diameter
ØD1	P	TiN	L1	L2	L3	ØD2	K	KI	Z	Ød1
M8	× 1.0	TTS38376	10	90	36	6	4.9	8	6	7.5
M10	× 1.25	TTS38436	13	100	40	7	5.5	8	6	9.4
M10	× 1.0	TTS38446	10	90	40	7	5.5	8	6	9.5
M12	× 1.25	TTS38526	13	100	40	9	7	10	6	11.4
M12	× 1.5	TTS38516	15	100	40	9	7	10	6	11.25
M14	× 1.5	TTS38556	15	100	40	11	9	12	8	13.25
M16	× 1.5	TTS38616	15	100	40	12	9	12	8	15.25
M18	× 1.5	TTS38676	17	110	44	14	11	14	8	17.25
M20	× 1.5	TTS38726	17	125	50	16	12	15	8	19.25

- ▶ Coating (TiAIN) is available on your request

◎ : Excellent ○ : Good

ISO	P											M				K					
	Non-alloy steel					Low alloy steel						High alloyed steel, and tool steel		Stainless steel		Grey cast iron		Nodular cast iron		Malleable cast iron	
Material Description	1	2	3	4	5	6	7	8	9	10	11	12	13	14	15	16	17	18	19	20	
VDI 3323	1	2	3	4	5	6	7	8	9	10	11	12	13	14	15	16	17	18	19	20	
HRc	13	25	28	32	30	10	29	32	38	15	35	15	23	10	10	26	3	25	21	21	
HB	125	190	250	270	300	180	275	300	350	200	325	200	240	180	180	275	160	250	130	230	
Recommended	◎	◎	◎	◎	◎	◎	◎	◎	◎	◎	◎	◎	◎	◎	◎	◎	◎	◎	◎	◎	◎

ISO	N										S					H						
	Aluminum-wrought alloy		Aluminum-cast, alloyed			Copper and Copper Alloys (Bronze / Brass)					Non Metallic Materials		Heat Resistant Super Alloys			Titanium Alloys		Hardened steel	Chilled Cast Iron	Hardened Cast Iron		
Material Description	21	22	23	24	25	26	27	28	29	30	31	32	33	34	35	36	37	38	39	40	41	
VDI 3323	21	22	23	24	25	26	27	28	29	30	31	32	33	34	35	36	37	38	39	40	41	
HRc	60	100	75	90	130	110	90	100			15	30	25	38	34		55	60	42	55	55	
HB	60	100	75	90	130	110	90	100			200	280	250	350	320	400Rm	1050Rm	550	630	400	550	
Recommended	◎	◎	◎	◎	◎	◎	◎	◎	◎	◎	◎	◎	◎	◎	◎	◎	◎	◎	◎	◎	◎	◎

M TIN-COATED HSS-PM COLD FORMING TAPS **NEW**
ISO Metric Coarse Threads DIN13

TTS39 SERIES



- ▶ Coated HSS-PM (Powder Metallurgy) Taps for high-speed tapping on rigid CNC machines or equivalent machines
- ▶ Up to 3 times faster in tapping compared to conventional taps
- ▶ For high-speed synchro tapping, synchro holder for increasing tool life and thread quality is recommended
- ▶ High precision threads

Short Chamfer

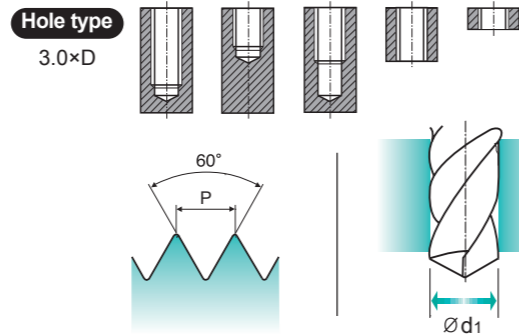
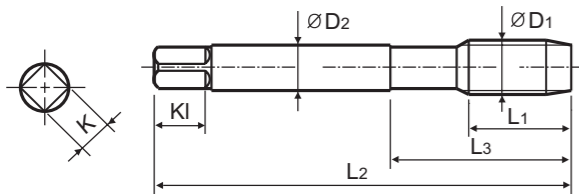

Material groups: **GV** HSS PM DIN 371/376 6HX 60° E TiN p.33

Unit : mm

SIZE	Pitch	EDP No.	Thread Length	Overall Length	Neck Length	Shank Diameter	Square Size	Square Length	Number of Oil Groove	Tapping Drill Diameter
ØD1	P	TiN	L1	L2	L3	ØD2	K	KI	Z	Ød1
M3	× 0.5	TTS39206	5	56	18	3.5	2.7	6	5	2.8
M4	× 0.7	TTS39246	7	63	21	4	3.4	6	5	3.7
M5	× 0.8	TTS39286	8	70	25	6	4.9	8	5	4.65
M6	× 1	TTS39316	10	80	30	6	4.9	8	5	5.55
M8	× 1.25	TTS39366	13	90	35	8	6.2	9	6	7.4
M10	× 1.5	TTS39426	15	100	39	10	8	11	6	9.3
M12	× 1.75	TTS39506	18	110	44	9	7	10	6	11.2
M14	× 2	TTS39546	20	110	44	11	9	12	8	13.0
M16	× 2	TTS39606	20	110	44	12	9	12	8	15.0
M18	× 2.5	TTS39656	25	125	50	14	11	14	8	16.8
M20	× 2.5	TTS39706	25	140	54	16	12	15	8	18.8

- ▶ DIN 371 (M3-M10) and DIN 376 (M12-M20)
- ▶ Coating (TiAIN) is available on your request

◎ : Excellent ○ : Good

ISO	P											M				K				
	Non-alloy steel					Low alloy steel						High alloyed steel, and tool steel		Stainless steel		Grey cast iron		Nodular cast iron		Malleable cast iron
Material Description	1	2	3	4	5	6	7	8	9	10	11	12	13	14	15	16	17	18	19	20
VDI 3323	1	2	3	4	5	6	7	8	9	10	11	12	13	14	15	16	17	18	19	20
HRc	13	25	28	32	30	10	29	32	38	15	35	15	23	10	10	26	3	25	21	21
HB	125	190	250	270	300	180	275	300	350	200	325	200	240	180	180	260	160	250	130	230
Recommended	◎	◎	◎	◎	◎	◎	◎			◎	◎	◎								

ISO	N					S					H										
	Aluminum-wrought alloy		Aluminum-cast, alloyed			Copper and Copper Alloys (Bronze / Brass)		Non Metallic Materials			Heat Resistant Super Alloys			Titanium Alloys		Hardened steel		Chilled Cast Iron		Hardened Cast Iron	
Material Description	21	22	23	24	25	26	27	28	29	30	31	32	33	34	35	36	37	38	39	40	41
VDI 3323	21	22	23	24	25	26	27	28	29	30	31	32	33	34	35	36	37	38	39	40	41
HRc	60	100	75	90	130	110	90	100			15	30	25	38	34	400Rm	1050Rm	55	60	42	55
HB	60	100	75	90	130	110	90	100			200	280	250	350	320	400Rm	1050Rm	550	630	400	550
Recommended	◎	◎	◎	◎	◎																

M TIN-COATED HSS-PM SPIRAL FLUTE TAPS **NEW**
ISO Metric Coarse Threads DIN13

TTS41-IC SERIES



- ▶ Coated HSS-PM (Powder Metallurgy) Taps for high-speed tapping on rigid CNC machines or equivalent machines
- ▶ Up to 3 times faster in tapping compared to conventional taps
- ▶ For high-speed synchro tapping, synchro holder for increasing tool life and thread quality is recommended
- ▶ High precision threads

with Internal Coolant

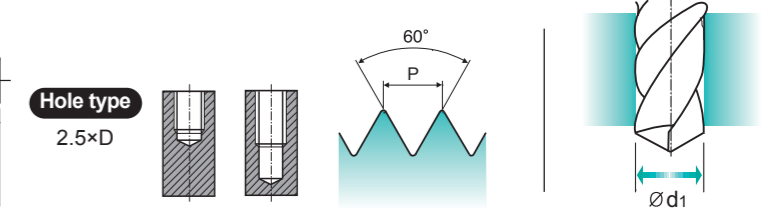
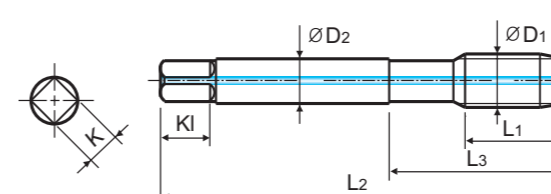

Material groups: **GS** HSS PM DIN 371/376 6HX 60° C R45° TiN p.33

Unit : mm

SIZE	Pitch	EDP No.	Thread Length	Overall Length	Neck Length	Shank Diameter	Square Size	Square Length	No. of Flute	Tapping Drill Diameter
ØD1	P	TiN	L1	L2	L3	ØD2	K	KI	Z	Ød1
M6	× 1.0	TTS41316IC	10	80	30	6	4.9	8	3	5.0
M8	× 1.25	TTS41366IC	13	90	35	8	6.2	9	3	6.8
M10	× 1.25	TTS41426IC	15	100	39	10	8	11	3	8.5
M12	× 1.75	TTS41506IC	18	110	44	9	7	10	3	10.2
M14	× 2.0	TTS41546IC	20	110	52	11	9	12	3	12.0
M16	× 2.0	TTS41606IC	20	110	52	12	9	12	3	14.0
M18	× 2.5	TTS41656IC	25	125	66	14	11	14	4	15.5
M20	× 2.5	TTS41706IC	25	140	72	16	12	15	4	17.5

- ▶ DIN 371 (M6-M10) and DIN 376 (M12-M20)
- ▶ Coating (TiAIN) is available on your request
- ▶ For Specific Nut To Accommodate Sealing Disk (See Page 31-32)

◎ : Excellent ○ : Good

ISO	P											M				K				
	Non-alloy steel					Low alloy steel						High alloyed steel, and tool steel		Stainless steel		Grey cast iron		Nodular cast iron		Malleable cast iron
Material Description	1	2	3	4	5	6	7	8	9	10	11	12	13	14	15	16	17	18	19	20
VDI 3323	1	2	3	4	5	6	7	8	9	10	11	12	13	14	15	16	17	18	19	20
HRc	13	25	28	32	30	10	29	32	38	15	35	15	23	10	10	26	3	25	21	21
HB	125	190	250	270	300	180	275	300	350	200	325	200	240	180	180	260	160	250	130	230
Recommended	◎	◎	◎	◎	◎	◎	◎			◎	◎	◎	◎	◎	◎	◎				

ISO	N					S					H										
	Aluminum-wrought alloy		Aluminum-cast, alloyed			Copper and Copper Alloys (Bronze / Brass)		Non Metallic Materials			Heat Resistant Super Alloys			Titanium Alloys		Hardened steel		Chilled Cast Iron		Hardened Cast Iron	
Material Description	21	22	23	24	25	26	27	28	29	30	31	32	33	34	35	36	37	38	39	40	41
VDI 3323	21	22	23	24	25	26	27	28	29	30	31	32	33	34	35	36	37	38	39	40	41
HRc	60	100	75	90	130	110	90	100			15	30	25	38	34	400Rm	1050Rm	55	60	42	55
HB	60	100	75	90	130	110	90	100			200	280	250	350	320	400Rm	1050Rm	550	630	400	550
Recommended	◎	◎	◎	◎	◎																

M TIN-COATED HSS-PM SPIRAL POINT TAPS **NEW**
ISO Metric Coarse Threads DIN13

TTS42-RCP SERIES



- ▶ Coated HSS-PM (Powder Metallurgy) Taps for high-speed tapping on rigid CNC machines or equivalent machines
- ▶ Up to 3 times faster in tapping compared to conventional taps
- ▶ For high-speed synchro tapping, synchro holder for increasing tool life and thread quality is recommended
- ▶ High precision threads

with Internal Coolant

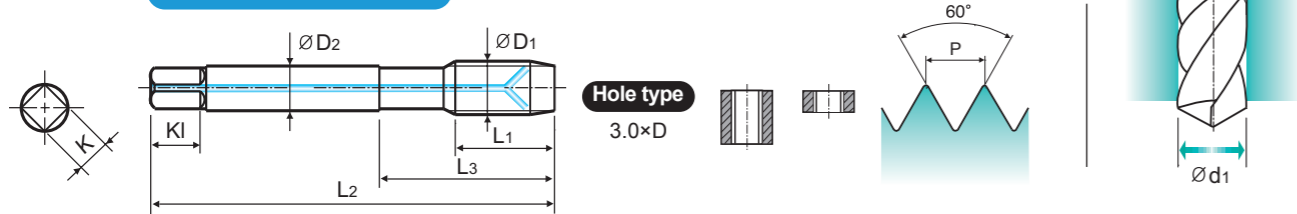

Hole type 3.0×D

Material groups: **GS** HSS PM DIN 371/376 6HX 60° B TiN p.33

Unit : mm

SIZE	Pitch	EDP No.	Thread Length	Overall Length	Neck Length	Shank Diameter	Square Size	Square Length	No. of Flute	Tapping Drill Diameter
ØD1	P	TiN	L1	L2	L3	ØD2	K	Kl	Z	Ød1
M6	× 1.0	TTS42316RCP	10	80	30	6	4.9	8	3	5.0
M8	× 1.25	TTS42366RCP	13	90	35	8	6.2	9	3	6.8
M10	× 1.5	TTS42426RCP	15	100	39	10	8	11	3	8.5
M12	× 1.75	TTS42506RCP	18	110	44	9	7	10	4	10.2
M14	× 2.0	TTS42546RCP	20	110	52	11	9	12	4	12.0
M16	× 2.0	TTS42606RCP	20	110	52	12	9	12	4	14.0
M18	× 2.5	TTS42656RCP	25	125	66	14	11	14	4	15.5
M20	× 2.5	TTS42706RCP	25	140	72	16	12	15	4	17.5

- ▶ DIN 371 (M6-M10) and DIN 376 (M12-M20)
- ▶ Coating (TiAlN) is available on your request
- ▶ For Specific Nut To Accommodate Sealing Disk (See Page 31-32)

◎ : Excellent ○ : Good

ISO	P											M				K						
	Non-alloy steel					Low alloy steel						High alloyed steel, and tool steel				Stainless steel		Grey cast iron		Nodular cast iron		Malleable cast iron
Material Description	1	2	3	4	5	6	7	8	9	10	11	12	13	14	15	16	17	18	19	20		
VDI 3323	1	2	3	4	5	6	7	8	9	10	11	12	13	14	15	16	17	18	19	20		
HRc	13	25	28	32	38	10	29	32	38	15	35	15	23	10	10	26	3	25	13	21		
HB	125	190	250	270	300	180	275	300	350	200	325	200	240	180	180	260	160	250	130	230		
Recommended	◎	◎	◎	◎	◎	◎	◎	◎	◎	◎	◎	◎	◎	◎	◎	◎	◎	◎	◎	◎		

ISO	N					S					H										
	Aluminum-wrought alloy		Aluminum-cast, alloyed			Copper and Copper Alloys (Bronze / Brass)			Non Metallic Materials		Heat Resistant Super Alloys			Titanium Alloys		Hardened steel		Chilled Cast Iron	Hardened Cast Iron		
Material Description	21	22	23	24	25	26	27	28	29	30	31	32	33	34	35	36	37	38	39	40	41
VDI 3323	21	22	23	24	25	26	27	28	29	30	31	32	33	34	35	36	37	38	39	40	41
HRc	60	100	75	90	130	110	90	100			15	30	25	38	34	400Rm	1050Rm	55	60	42	55
HB	60	100	75	90	130	110	90	100			200	280	250	350	320	400Rm	1050Rm	550	630	400	550
Recommended	◎	◎	◎	◎	◎	◎	◎	◎	◎	◎	◎	◎	◎	◎	◎	◎	◎	◎	◎	◎	◎

M TICN-COATED HSS-PM STRAIGHT FLUTE TAPS **NEW**
ISO Metric Coarse Threads DIN13

TKS43-IC SERIES



- ▶ Coated HSS-PM (Powder Metallurgy) Taps for high-speed tapping on rigid CNC machines or equivalent machines
- ▶ Up to 3 times faster in tapping compared to conventional taps
- ▶ For high-speed synchro tapping, synchro holder for increasing tool life and thread quality is recommended
- ▶ High precision threads

with Internal Coolant

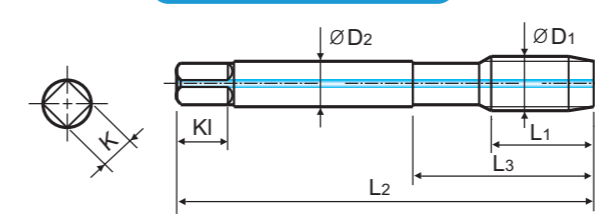

Hole type 2.0×D

Material groups: **GG** HSS PM DIN 371/376 6HX 60° C TiCN p.33

Unit : mm

SIZE	Pitch	EDP No.	Thread Length	Overall Length	Neck Length	Shank Diameter	Square Size	Square Length	No. of Flute	Tapping Drill Diameter
ØD1	P	TiCN	L1	L2	L3	ØD2	K	Kl	Z	Ød1
M6	× 1.0	TKS43316IC	10	80	30	6	4.9	8	3	5.0
M8	× 1.25	TKS43366IC	13	90	35	8	6.2	9	3	6.8
M10	× 1.5	TKS43426IC	15	100	39	10	8	11	4	8.5
M12	× 1.75	TKS43506IC	18	110	44	9	7	10	4	10.2
M14	× 2.0	TKS43546IC	20	110	52	11	9	12	4	12.0
M16	× 2.0	TKS43606IC	20	110	52	12	9	12	4	14.0
M18	× 2.5	TKS43656IC	25	125	66	14	11	14	4	15.5
M20	× 2.5	TKS43706IC	25	140	72	16	12	15	4	17.5

- ▶ DIN 371 (M6-M10) and DIN 376 (M12-M20)
- ▶ Coating (TiAlN) is available on your request
- ▶ For Specific Nut To Accommodate Sealing Disk (See Page 31-32)

◎ : Excellent ○ : Good

ISO	P											M				K						
	Non-alloy steel					Low alloy steel						High alloyed steel, and tool steel				Stainless steel		Grey cast iron		Nodular cast iron		Malleable cast iron
Material Description	1	2	3	4	5	6	7	8	9	10	11	12	13	14	15	16	17	18	19	20		
VDI 3323	1	2	3	4	5	6	7	8	9	10	11	12	13	14	15	16	17	18	19	20		
HRc	13	25	28	32	38	10	29	32	38	15	35	15	23	10	10	26	3	25	13	21		
HB	125	190	250	270	300	180	275	300	350	200	325	200	240	180	180	260	160	250	130	230		
Recommended	◎	◎	◎	◎	◎	◎	◎	◎	◎	◎	◎	◎	◎	◎	◎	◎	◎	◎	◎	◎		

ISO	N					S					H										
	Aluminum-wrought alloy		Aluminum-cast, alloyed			Copper and Copper Alloys (Bronze / Brass)			Non Metallic Materials		Heat Resistant Super Alloys			Titanium Alloys		Hardened steel		Chilled Cast Iron	Hardened Cast Iron		
Material Description	21	22	23	24	25	26	27	28	29	30	31	32	33	34	35	36	37	38	39	40	41
VDI 3323	21	22	23	24	25	26	27	28	29	30	31	32	33	34	35	36	37	38	39	40	41
HRc	60	100	75	90	130	110	90	100			15	30	25	38	34	400Rm	1050Rm	55	60	42	55
HB	60	100	75	90	130	110	90	100			200	280	250	350	320	400Rm	1050Rm	550	630	400	550
Recommended	◎	◎	◎	◎	◎	◎	◎	◎	◎	◎	◎	◎	◎	◎	◎	◎	◎	◎	◎	◎	◎

M TiCN-COATED HSS-PM STRAIGHT FLUTE TAPS **NEW**
ISO Metric Coarse Threads DIN13

TKS44-RCP SERIES



- ▶ Coated HSS-PM (Powder Metallurgy) Taps for high-speed tapping on rigid CNC machines or equivalent machines
- ▶ Up to 3 times faster in tapping compared to conventional taps
- ▶ For high-speed synchro tapping, synchro holder for increasing tool life and thread quality is recommended
- ▶ High precision threads

with Internal Coolant

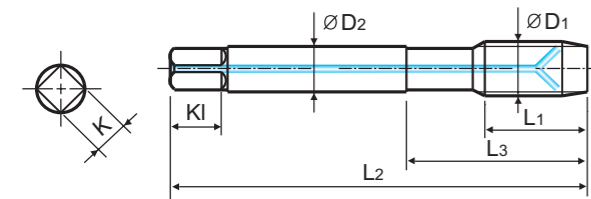
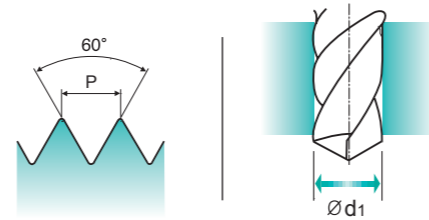

Material groups **GG** HSS PM DIN 371/376 6HX 60° C TiCN p.33

Unit : mm

SIZE	Pitch	EDP No.	Thread Length	Overall Length	Neck Length	Shank Diameter	Square Size	Square Length	No. of Flute	Tapping Drill Diameter
ØD1	P	TiCN	L1	L2	L3	ØD2	K	KI	Z	Ød1
M6	× 1.0	TKS44316RCP	10	80	30	6	4.9	8	3	5.0
M8	× 1.25	TKS44366RCP	13	90	35	8	6.2	9	3	6.8
M10	× 1.5	TKS44426RCP	15	100	39	10	8	11	4	8.5
M12	× 1.75	TKS44506RCP	18	110	44	9	7	10	4	10.2
M14	× 2.0	TKS44546RCP	20	110	52	11	9	12	4	12.0
M16	× 2.0	TKS44606RCP	20	110	52	12	9	12	4	14.0
M18	× 2.5	TKS44656RCP	25	125	66	14	11	14	4	15.5
M20	× 2.5	TKS44706RCP	25	140	72	16	12	15	4	17.5

- ▶ DIN 371 (M6-M10) and DIN 376 (M12-M20)
- ▶ Coating (TiAlN) is available on your request
- ▶ For Specific Nut To Accommodate Sealing Disk (See Page 31-32)

◎ : Excellent ○ : Good

ISO	P											M				K					
	Non-alloy steel					Low alloy steel						High alloyed steel, and tool steel		Stainless steel		Grey cast iron		Nodular cast iron		Malleable cast iron	
Material Description	1	2	3	4	5	6	7	8	9	10	11	12	13	14	15	16	17	18	19	20	
VDI 3323	1	2	3	4	5	6	7	8	9	10	11	12	13	14	15	16	17	18	19	20	
HRc	13	25	28	32	30	10	29	32	38	15	35	15	23	10	10	26	3	25	13	21	
HB	125	190	250	270	300	180	275	300	350	200	325	200	240	180	180	260	160	250	130	230	
Recommended	○	○	○	○	○	○	○	○	○	○	○	○	○	○	○	○	○	○	○	○	○

ISO	N								S							H					
	Aluminum-wrought alloy		Aluminum-cast, alloyed			Copper and Copper Alloys (Bronze / Brass)			Non Metallic Materials	Heat Resistant Super Alloys				Titanium Alloys			Hardened steel		Chilled Cast Iron	Hardened Cast Iron	
Material Description	21	22	23	24	25	26	27	28	29	30	31	32	33	34	35	36	37	38	39	40	41
VDI 3323	21	22	23	24	25	26	27	28	29	30	31	32	33	34	35	36	37	38	39	40	41
HRc	60	100	75	90	130	110	90	100			15	30	25	38	34		55	60	42	55	
HB	60	100	75	90	130	110	90	100			200	280	250	350	320	400Rm	1050Rm	550	630	400	550
Recommended	○	○	○	○	○	○	○	○	○	○	○	○	○	○	○	○	○	○	○	○	○

M TiN-COATED HSS-PM COLD FORMING TAPS **NEW**
ISO Metric Coarse Threads DIN13

TTS45-RCP SERIES



- ▶ Coated HSS-PM (Powder Metallurgy) Taps for high-speed tapping on rigid CNC machines or equivalent machines
- ▶ Up to 3 times faster in tapping compared to conventional taps
- ▶ For high-speed synchro tapping, synchro holder for increasing tool life and thread quality is recommended
- ▶ High precision threads

with Internal Coolant

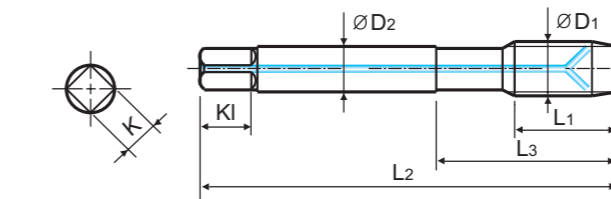
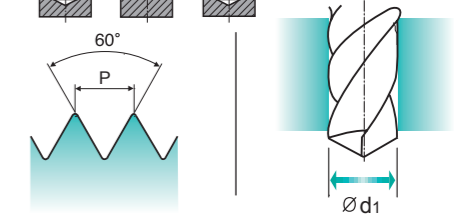
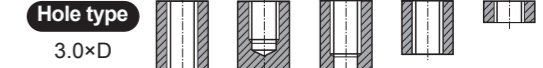

Material groups **GV** HSS PM DIN 371/376 6HX 60° C TiN p.33

Unit : mm

SIZE	Pitch	EDP No.	Thread Length	Overall Length	Neck Length	Shank Diameter	Square Size	Square Length	Number of Oil Groove	Tapping Drill Diameter
ØD1	P	TiN	L1	L2	L3	ØD2	K	KI	Z	Ød1
M5	× 0.8	TTS45286RCP	8	70	25	6	4.9	8	5	4.65
M6	× 1.0	TTS45316RCP	10	80	30	6	4.9	8	5	5.55
M8	× 1.25	TTS45366RCP	13	90	35	8	6.2	9	6	7.4
M10	× 1.5	TTS45426RCP	15	100	39	10	8	11	6	9.3
M12	× 1.75	TTS45506RCP	18	110	44	9	7	10	6	11.2
M14	× 2.0	TTS45546RCP	20	110	52	11	9	12	8	13.0
M16	× 2.0	TTS45606RCP	20	110	52	12	9	12	8	15.0
M18	× 2.5	TTS45656RCP	25	125	66	14	11	14	8	16.8
M20	× 2.5	TTS45706RCP	25	140	72	16	12	15	8	18.8

- ▶ DIN 371 (M5-M10) and DIN 376 (M12-M20)
- ▶ Coating (TiAlN) is available on your request
- ▶ For Specific Nut To Accommodate Sealing Disk (See Page 31-32)

◎ : Excellent ○ : Good

ISO	P											M				K					
	Non-alloy steel					Low alloy steel						High alloyed steel, and tool steel		Stainless steel		Grey cast iron		Nodular cast iron		Malleable cast iron	
Material Description	1	2	3	4	5	6	7	8	9	10	11	12	13	14	15	16	17	18	19	20	
VDI 3323	1	2	3	4	5	6	7	8	9	10	11	12	13	14	15	16	17	18	19	20	
HRc	13	25	28	32	30	10	29	32	38	15	35	15	23	10	10	26	3	25	13	21	
HB	125	190	250	270	300	180	275	300	350	200	325	200	240	180	180	260	160	250	130	230	
Recommended	◎	◎	◎	◎	◎	◎	◎	◎	◎	◎	◎	◎	◎	◎	◎	◎	◎	◎	◎	◎	◎

ISO	N								S							H					
	Aluminum-wrought alloy		Aluminum-cast, alloyed			Copper and Copper Alloys (Bronze / Brass)			Non Metallic Materials	Heat Resistant Super Alloys				Titanium Alloys			Hardened steel		Chilled Cast Iron	Hardened Cast Iron	
Material Description	21	22	23	24	25	26	27	28	29	30	31	32	33	34	35	36	37	38	39	40	41
VDI 3323	21	22	23	24	25	26	27	28	29	30	31	32	33	34	35	36	37	38	39	40	41
HRc	60	100	75	90	130	110	90	100			15	30	25	38	34		55	60	42	55	
HB	60	100	75	90	130	110	90	100			200	280	250	350	320	400Rm	1050Rm	550	630	400	550
Recommended	◎	◎	◎	◎	○	◎	◎	◎	◎	◎	◎	◎	◎	◎	◎	◎	◎	◎	◎	◎	◎

SYTER

SYNCHRO TAPPING CHUCK (ER TYPE)

DIN 69871-SK

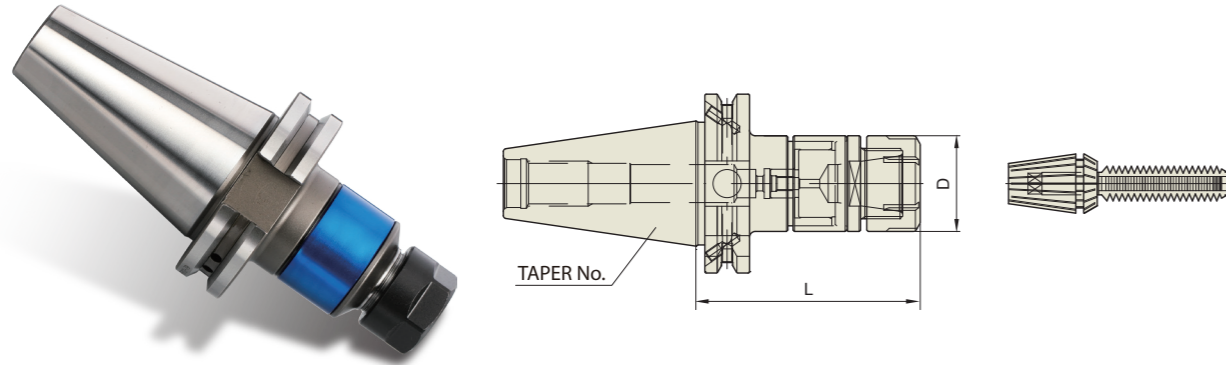

Unit : mm

TAPER No.	MODEL No.	EDP No.	TAP SIZE	NUT	D	L	WEIGHT (kg)
40	SK40AD/B-SYTER12-79	P2773701	M3-M12	ER16	28	79	1.00
	SK40AD/B-SYTER16-85	P2773702	M3-M16	ER20	34	85	1.08
	SK40AD/B-SYTER20-90	P2773703	M3-M20	ER25	42	90	1.08
	SK40AD/B-SYTER27-100	P2773704	M4-M27	ER32	50	100	1.37
	SK40AD/B-SYTER33-120	P2773705	M4-M33	ER40	63	120	2.16
50	SK50AD/B-SYTER12-79	P2773706	M3-M12	ER16	28	79	2.83
	SK50AD/B-SYTER16-85	P2773707	M3-M16	ER20	34	85	2.86
	SK50AD/B-SYTER20-90	P2773708	M3-M20	ER25	42	90	2.87
	SK50AD/B-SYTER27-100	P2773709	M4-M27	ER32	50	100	3.04
	SK50AD/B-SYTER33-105	P2773710	M4-M33	ER40	63	105	3.93

- Feature :
- To compensate for synchronization errors to extend tap life and to improve thread quality
 - To compensate for pitch tolerances of taps
 - For machine with synchronized spindle
- CAT (ANSI B5.50) taper and Inch type products are available

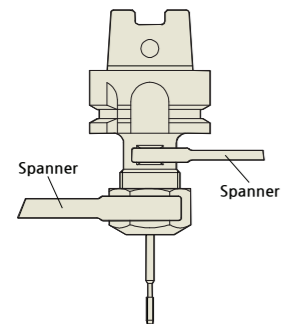

- Tightening the clamping nut with the wrenches
- In order to avoid damage to the holder, please use 2-spanners
- One is for holder body, the other is for clamping nut

SYTER

SYNCHRO TAPPING CHUCK (ER TYPE)

DIN 69893/
ISO 12164-1-HSK FORM A

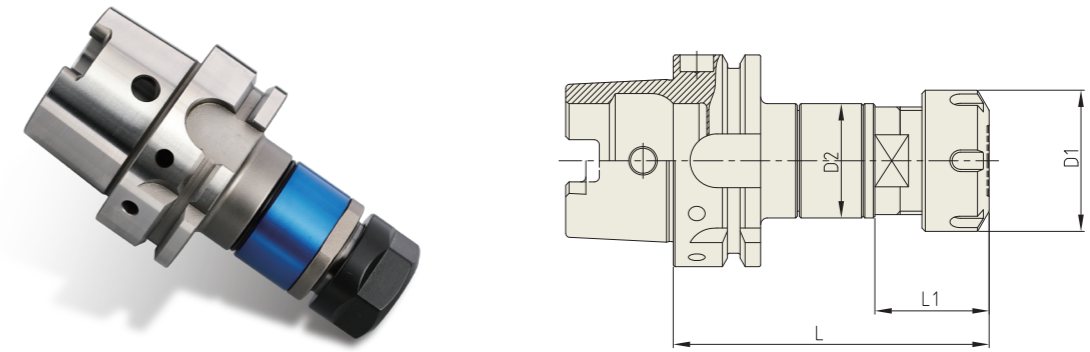

Unit : mm

TAPER No.	MODEL No.	EDP No.	TAP SIZE	NUT	D1	D2	L	L1	Tension/Compression	WEIGHT (kg)
63A	HSK63A-SYTER12-105	P2773812	M3-M12	ER16	28	34	105	31	±0.2	
	HSK63A-SYTER16-106	P2773808	M3-M16	ER20	34	34	106	31	±0.2	0.95
	HSK63A-SYTER16-120	P2773804	M3-M16	ER20	34	34	120	31	±0.2	
	HSK63A-SYTER20-110	P2773809	M3-M20	ER25	42	34	110	37.5	±0.2	0.95
	HSK63A-SYTER20-120	P2773805	M3-M20	ER25	42	34	120	37.5	±0.2	
	HSK63A-SYTER27-115	P2773810	M4-M27	ER32	50	45	115	41	±0.2	1.34
	HSK63A-SYTER27-155	P2773813	M4-M27	ER32	50	45	155	41	±0.2	
	HSK63A-SYTER33-130	P2773814	M4-M33	ER40	63	62	130	60	±0.2	
100A	HSK100A-SYTER20-106	P2773807	M3-M20	ER25	42	34	106	36	±0.2	0.95
	HSK100A-SYTER27-124	P2773815	M4-M27	ER32	50	45	124	41	±0.2	
	HSK100A-SYTER27-155	P2773816	M4-M27	ER32	50	45	155	41	±0.2	
	HSK100A-SYTER33-135	P2773817	M4-M33	ER40	63	62	135	60	±0.2	

- Feature :
- To compensate for synchronization errors to extend tap life and to improve thread quality
 - To compensate for pitch tolerances of taps
 - For machine with synchronized spindle
- Inch size products are available

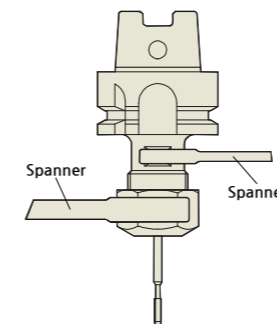

- Tightening the clamping nut with the wrenches
- In order to avoid damage to the holder, please use 2-spanners
- One is for holder body, the other is for clamping nut

SYTER

SYNCHRO TAPPING CHUCK (ER TYPE)

JIS B6339/
MAS 403-BT

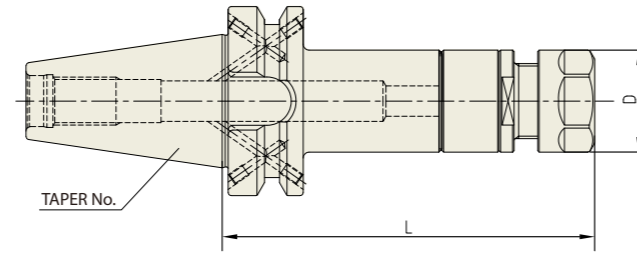

Unit : mm

TAPER No.	MODEL No.	EDP No.	TAP SIZE	NUT	D	L	WEIGHT (kg)
40	BT40AD/B-SYTER12-79	P2776301	M2-M8	ER16	28	79	1.14
	BT40AD/B-SYTER16-85	P2776302	M3-M10	ER20	34	85	1.17
	BT40AD/B-SYTER20-90	P2776303	M3-M14	ER25	42	90	1.17
	BT40AD/B-SYTER27-100	P2776304	M4-M18	ER32	50	100	1.45
	BT40AD/B-SYTER33-125	P2776305	M8-M24	ER40	63	125	2.40
50	BT50AD/B-SYTER12-100	P2776306	M2-M8	ER16	28	100	3.79
	BT50AD/B-SYTER16-100	P2776307	M3-M10	ER20	34	100	3.79
	BT50AD/B-SYTER20-100	P2776308	M3-M14	ER25	42	100	3.75
	BT50AD/B-SYTER27-110	P2776309	M4-M18	ER32	50	110	3.99
	BT50AD/B-SYTER33-125	P2776310	M8-M24	ER40	63	125	4.75

- Feature :
- To compensate for synchronization errors to extend tap life and to improve thread quality
 - To compensate for pitch tolerances of taps
 - For machine with synchronized spindle
- CAT (ANSI B5.50) taper and Inch type products are available

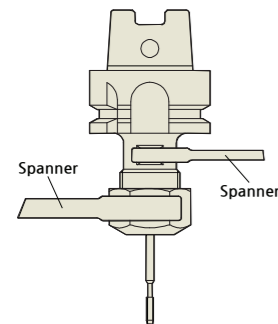

- Tightening the clamping nut with the wrenches
- In order to avoid damage to the holder, please use 2-spanners
- One is for holder body, the other is for clamping nut

SYTER

SYNCHRO TAPPING CHUCK (ER TYPE)

STRAIGHT-KW

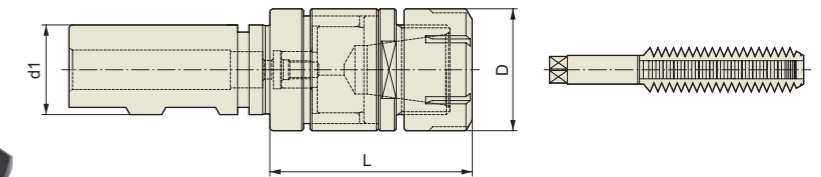

Unit : mm

MODEL No.	EDP No.	TAP SIZE	NUT / COLLET	D	L	d1	WEIGHT (kg)
KW20-SYTER16	P2773901	M3-M16	ER20	34	58	20	0.33
KW25-SYTER16	P2773902	M3-M16	ER20	34	61	25	0.44
KW25-SYTER27	P2773903	M4-M27	ER32	50	69	25	0.60

- Feature :
- To compensate for synchronization errors to extend tap life and to improve thread quality
 - To compensate for pitch tolerances of taps
 - For machine with synchronized spindle

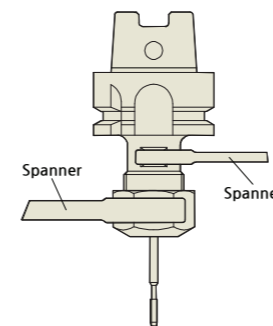

- Tightening the clamping nut with the wrenches
- In order to avoid damage to the holder, please use 2-spanners
- One is for holder body, the other is for clamping nut

SYTC

SYNCHRO TAPPING CHUCK (QUICK CHANGE TYPE)

DIN69871-SK

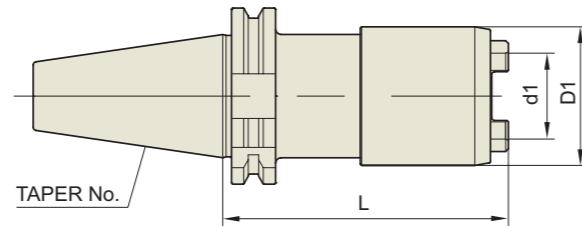
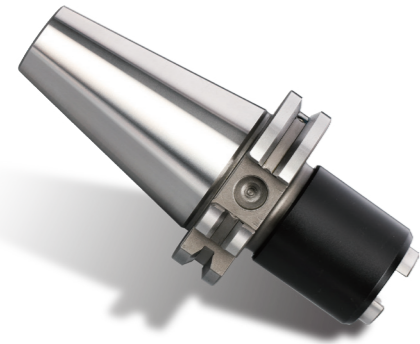

Unit : mm

TAPER No.	MODEL No.	EDP No.	TAP SIZE	MATCHING INSERTS	d1	D1	L	WEIGHT (kg)
30	SK30-SYTC12-65	P2774207	M3-M12	TCS12	19	36	65	0.50
	SK30-SYTC20-89	P2774208	M6-M24	TCS24	31	50	89	1.00
40	SK40-SYTC12-65	P2774201	M3-M12	TCS12	19	36	65	1.10
	SK40-SYTC20-79	P2774202	M6-M24	TCS24	31	50	79	1.50
50	SK50-SYTC12-65	P2774204	M3-M12	TCS12	19	36	65	3.00
	SK50-SYTC20-79	P2774205	M6-M24	TCS24	31	50	79	3.30
	SK50-SYTC33-115	P2774206	M18-M38	TCS38	48	74	115	5.20

- Feature :
- To compensate for synchronization errors to extend tap life and to improve thread quality
 - To compensate for pitch tolerances of taps
 - For machine with synchronized spindle
- CAT (ANSI B5.50) taper and Inch type products are available

SYTC

SYNCHRO TAPPING CHUCK (QUICK CHANGE TYPE)

DIN 69893/
ISO 12164-1-HSK FORM A

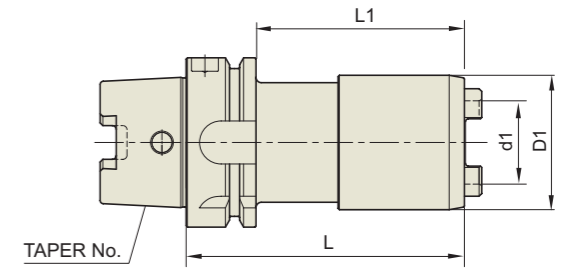

Unit : mm

TAPER No.	MODEL No.	EDP No.	TAP SIZE	MATCHING INSERTS	d1	D1	L	L1	WEIGHT (kg)
32A	HSK32A-SYTC12-75	P2774314	M3-M12	TCS12	19	36	75	55	0.32
50A	HSK50A-SYTC12-72	P2774315	M3-M12	TCS12	19	36	72	46	0.54
	HSK50A-SYTC20-91	P2774316	M6-M24	TCS24	31	50	91	65	0.70
63A	HSK63A-SYTC12-75	P2774301	M3-M12	TCS12	19	36	75	49	0.82
	HSK63A-SYTC12-80	P2774302	M3-M12	TCS12	19	36	80	54	0.85
	HSK63A-SYTC12-120	P2774303	M3-M12	TCS12	19	36	120	94	1.08
	HSK63A-SYTC12-152	P2774304	M3-M12	TCS12	19	36	152	126	1.27
	HSK63A-SYTC12-180	P2774305	M3-M12	TCS12	19	36	180	154	1.44
	HSK63A-SYTC20-89	P2774306	M6-M24	TCS24	31	50	89	63	0.84
100A	HSK63A-SYTC33-121	P2774307	M18-M38	TCS38	48	74	121	95	1.45
	HSK100A-SYTC12-75	P2774308	M3-M12	TCS12	19	36	75	43	2.20
	HSK100A-SYTC12-160	P2774309	M3-M12	TCS12	19	36	160	131	2.60
	HSK100A-SYTC20-94	P2774310	M6-M24	TCS24	31	50	94	65	2.39
	HSK100A-SYTC20-160	P2774311	M6-M24	TCS24	31	50	160	131	2.99
	HSK100A-SYTC33-127	P2774312	M18-M38	TCS38	48	74	127	98	3.11
	HSK100A-SYTC33-160	P2774313	M18-M38	TCS38	48	74	160	131	4.03

- Feature :
- To compensate for synchronization errors to extend tap life and to improve thread quality
 - To compensate for pitch tolerances of taps
 - For machine with synchronized spindle

SYTC

TC

SYNCHRO TAPPING CHUCK (QUICK CHANGE TYPE) STRAIGHT-KW

TAP ADAPTER (DIN) Below standard Tap Adapter conforms to DIN

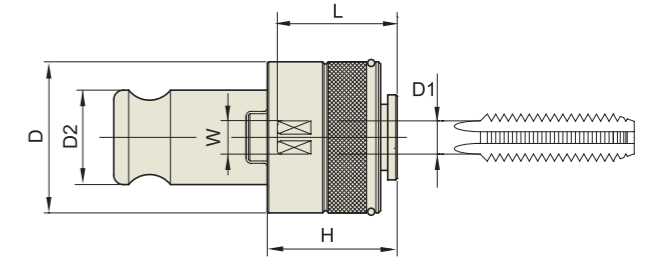
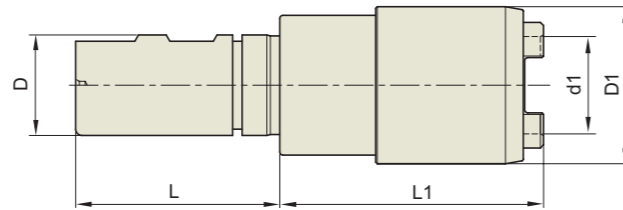

Unit : mm										
TAPER No.	MODEL No.	EDP No.	TAP SIZE	TAP ADAPTOR	D	d1	D1	L	L1	WEIGHT (kg)
20	KW20-SYTC12-46	P2774401	M3-M12	TCS12	20	19	36	50	46	0.28
	KW20-SYTC12-107.5	P2774406	M3-M12	TCS12	20	19	36	50	107.5	0.65
25	KW25-SYTC12-46	P2774402	M3-M12	TCS12	25	19	36	56	46	0.37
	KW25-SYTC20-74	P2774403	M6-M24	TCS24	25	31	50	56	74	0.69
32	KW25-SYTC33-107.5	P2774404	M18-M38	TCS38	25	48	74	56	107.5	1.32
	KW32-SYTC12-74	P2774405	M3-M12	TCS12	32	31	50	60	74	0.71

- Feature :
- To compensate for synchronization errors to extend tap life and to improve thread quality
 - To compensate for pitch tolerances of taps
 - For machine with synchronized spindle

Unit : mm										
TAPER No.	MODEL No.	EDP No.	D	D1 (Ø)	D2	H	W (□)	L	DIN No.	WEIGHT (kg)
TSC12D	TCS12D-2821	P2774601	32	2.8	19	25	2.1	24	371	0.20
	TCS12D-3527	P2774602	32	3.5	19	25	2.7	24	371	0.20
	TCS12D-4534	P2774603	32	4.5	19	25	3.4	24	371	0.20
	TCS12D-43	P2774604	32	4	19	25	3	24	371	0.20
	TCS12D-5543	P2774605	32	5.5	19	25	4.3	25	376	0.20
	TCS12D-649	P2774606	32	6	19	25	4.9	25	371	0.20
	TCS12D-755	P2774607	32	7	19	25	5.5	25	376	0.20
	TCS12D-862	P2774608	32	8	19	25	6.2	25	371	0.20
	TCS12D-97	P2774609	32	9	19	25	7	26	376	0.20
	TCS12D-108	P2774610	32	10	19	25	8	26	371	0.20
TCS24D	TCS12D-119	P2774611	32	11	19	25	9	26	376	0.20
	TCS24D-649	P2774612	52	6	31	33	4.9	38	371	0.60
	TCS24D-755	P2774613	52	7	31	33	5.5	38	376	0.60
	TCS24D-862	P2774614	52	8	31	33	6.2	38	371	0.60
	TCS24D-97	P2774615	52	9	31	33	7	38	376	0.60
	TCS24D-108	P2774616	52	10	31	33	8	39	371	0.60
	TCS24D-119	P2774617	52	11	31	33	9	41	376	0.60
	TCS24D-129	P2774618	52	12	31	33	9	43	376	0.60
	TCS24D-1411	P2774619	52	14	31	33	11	43	376	0.60
	TCS24D-1612	P2774620	52	16	31	33	12	46	376	0.60
TCS38D	TCS24D-18145	P2774621	52	18	31	33	14.5	46	376	0.60
	TCS38D-119	P2774622	72	11	48	45	9	43	376	1.80
	TCS38D-129	P2774623	72	12	48	45	9	43	376	1.80
	TCS38D-1411	P2774624	72	14	48	45	11	45	376	1.80
	TCS38D-1612	P2774625	72	16	48	45	12	45	376	1.80
	TCS38D-18145	P2774626	72	18	48	45	14.5	62	376	1.80
	TCS38D-2016	P2774627	72	20	48	45	16	64	376	1.80
	TCS38D-2218	P2774628	72	22	48	45	18	66	376	1.80
	TCS38D-2520	P2774629	72	25	48	45	20	68	376	1.80
	TCS38D-2822	P2774630	72	28	48	45	22	68	376	1.80

- Feature : Quick Change Type with Built-in Torque Safety Device
 ► For Pipe Type Tap, please discuss separately

RDTC

TAP ER COLLET (DIN)

Below standard Tap ER Collet conforms to **DIN**

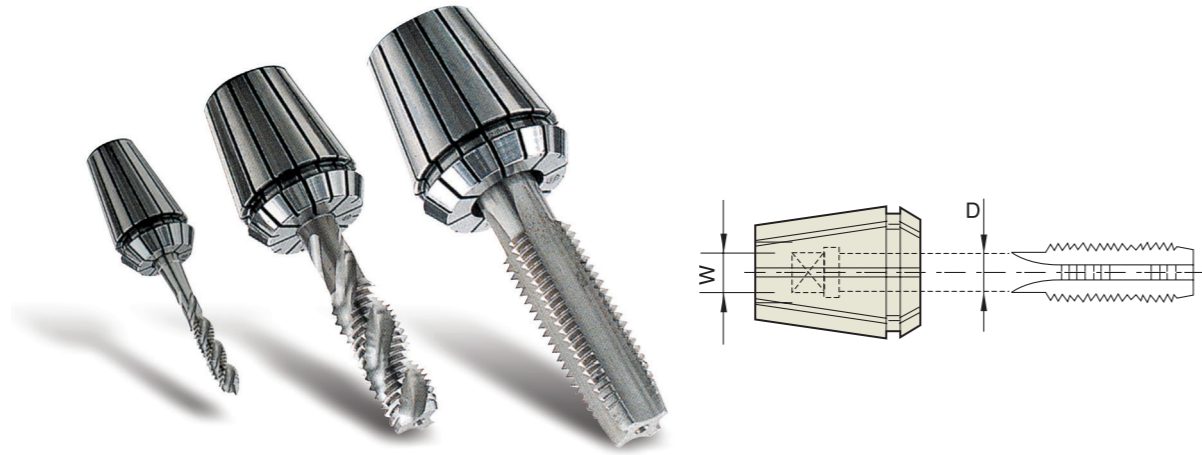

Unit : mm

DIN STANDARD			RD 11TC			RD 16TC			RD 20TC			RD 25TC			RD 32TC			RD 40TC			RD 50TC				
DIN 374/376	DIN 352/2181	DIN 371	D (Ø)	W (□)	EDP No.	D (Ø)	W (□)	EDP No.	D (Ø)	W (□)	EDP No.	D (Ø)	W (□)	EDP No.	D (Ø)	W (□)	EDP No.	D (Ø)	W (□)	EDP No.	D (Ø)	W (□)	EDP No.		
M5	M3	M3	3.5	2.7	P2772501D	3.5	2.7	P2772507D	3.5	2.7	P2772514D	3.5	2.7	P2772524D	3.5	2.7	P2772538D	3.5	2.7	P2772552D					
M5.5	M3.5	M3.5	4.0	3.0	P2772502D	4.0	3.0	P2772508D	4.0	3.0	P2772515D	4.0	3.0	P2772525D	4.0	3.0	P2772539D	4.0	3.0	P2772553D					
M6	M4	M4	4.5	3.4	P2772503D	4.5	3.4	P2772509D	4.5	3.4	P2772516D	4.5	3.4	P2772526D	4.5	3.4	P2772540D	4.5	3.4	P2772554D					
M5	-	-	5.0	4.0	P2772504D	5.0	4.0	P2772510D	5.0	4.0	P2772517D	5.0	4.0	P2772527D	5.0	4.0	P2772541D	5.0	4.0	P2772555D					
M7	-	-	5.5	4.3	P2772505D	5.5	4.3	P2772511D	5.5	4.3	P2772518D	5.5	4.3	P2772528D	5.5	4.3	P2772542D	5.5	4.3	P2772556D					
M8	M4.5-M8	M4.5-M8	6.0	4.9	P2772506D	6.0	4.9	P2772512D	6.0	4.9	P2772519D	6.0	4.9	P2772529D	6.0	4.9	P2772543D	6.0	4.9	P2772557D					
M9+M10	M9+M10	M7				7.0	5.5	P2772513D	7.0	5.5	P2772520D	7.0	5.5	P2772530D	7.0	5.5	P2772544D	7.0	5.5	P2772558D					
M11	M11	M8							8.0	6.2	P2772521D	8.0	6.2	P2772531D	8.0	6.2	P2772545D	8.0	6.2	P2772559D	8.0	6.2	P2772569D		
M12	M12	M9							9.0	7.0	P2772522D	9.0	7.0	P2772532D	9.0	7.0	P2772546D	9.0	7.0	P2772560D	9.0	7.0	P2772570D		
-	-	M10							10.0	8.0	P2772523D	10.0	8.0	P2772533D	10.0	8.0	P2772547D	10.0	8.0	P2772561D	10.0	8.0	P2772571D		
M13+M14	M13+M14	-										11.0	9.0	P2772534D	11.0	9.0	P2772548D	11.0	9.0	P2772562D	11.0	9.0	P2772572D		
M15-M17	M15-M17	-										12.0	9.0	P2772535D	12.0	9.0	P2772549D	12.0	9.0	P2772563D	12.0	9.0	P2772573D		
M18+M19	M18+M19	-										14.0	11.0	P2772536D	14.0	11.0	P2772550D	14.0	11.0	P2772564D	14.0	11.0	P2772574D		
M20+M21	M20+M21	-										16.0	12.0	P2772537D	16.0	12.0	P2772551D	16.0	12.0	P2772565D	16.0	12.0	P2772575D		
M22-M26	M22-M26	-																18.0	14.5	P2772566D	18.0	14.5	P2772576D		
M27+M28	M27+M28	-																20.0	16.0	P2772567D	20.0	16.0	P2772577D		
M29-M32	M29-M32	-																22.0	18.0	P2772568D	22.0	18.0	P2772578D		
M33	M33	-																			25.0	20.0	P2772579D		
M34-M38	M34-M38	-																				28.0	22.0	P2772580D	
M39-M42	M39-M42	-																				32.0	24.0	P2772581D	

▶ Inch type collets available

PART

ER COLLET CHUCK (ER NUT)

For Accommodating Sealing Disk for Internal Coolant

DIN 6499/ISO 15488

■ XSQ-RT (Sealing Disk Type: Hex.)

Unit : mm

MODEL No.	EDP No.	THREAD	Dia.	LENGTH
XSQ-RT16	P2777009	M22×1.50	28.0	22.5
XSQ-RT20	P2777010	M25×1.50	34.0	24.0



■ XSQ-RUT (Sealing Disk Type: Round)

Unit : mm

MODEL No.	EDP No.	THREAD	Dia.	LENGTH
XSQ-RUT16	P2777011	M22×1.50	32.0	22.5
XSQ-RUT20	P2777012	M25×1.50	35.0	24.0
XSQ-RUT25	P2777013	M32×1.50	42.0	25.0
XSQ-RUT32	P2777014	M40×1.50	50.0	27.5
XSQ-RUT40	P2777015	M50×1.50	63.0	30.5



- ▶ The basic assembled ER Nuts on the Synchro Tapping Chuck (ER type) does not support internal cooling
- ▶ If you would like to use Internal coolant feature, you should replace the basic ER Nuts to above ER Nuts (Sealing Disk Type) and add the Sealing disks on the next page

DS

SEALING DISK



SEALING DISK

MODEL No.	EDP No.	Dia.	INNER DIA. (Step : 0.5mm)	THICKNESS
DS/ER16-3	P2780501	13.0	3.0	4.0
DS/ER16-3.5	P2780502	13.0	3.5	4.0
DS/ER16-4	P2780503	13.0	4.0	4.0
DS/ER16-4.5	P2780504	13.0	4.5	4.0
DS/ER16-5	P2780505	13.0	5.0	4.0
DS/ER16-6	P2780506	13.0	6.0	4.0
DS/ER16-6.5	P2780507	13.0	6.5	4.0
DS/ER16-7	P2780508	13.0	7.0	4.0
DS/ER16-8	P2780509	13.0	8.0	4.0
DS/ER16-9	P2780510	13.0	9.0	4.0
DS/ER16-10	P2780511	13.0	10.0	4.0
DS/ER20-3	P2780512	16.0	3.0	4.0
DS/ER20-4	P2780513	16.0	4.0	4.0
DS/ER20-4.5	P2780514	16.0	4.5	4.0
DS/ER20-5	P2780515	16.0	5.0	4.0
DS/ER20-5.5	P2780516	16.0	5.5	4.0
DS/ER20-6	P2780517	16.0	6.0	4.0
DS/ER20-6.5	P2780518	16.0	6.5	4.0
DS/ER20-7	P2780519	16.0	7.0	4.0
DS/ER20-7.5	P2780520	16.0	7.5	4.0
DS/ER20-8	P2780521	16.0	8.0	4.0
DS/ER20-8.5	P2780522	16.0	8.5	4.0
DS/ER20-9	P2780523	16.0	9.0	4.0
DS/ER20-10	P2780524	16.0	10.0	4.0
DS/ER20-11	P2780525	16.0	11.0	4.0
DS/ER20-12	P2780526	16.0	12.0	4.0
DS/ER20-13	P2780527	16.0	13.0	4.0
DS/ER25-3	P2780528	21.0	3.0	4.0
DS/ER25-3.5	P2780529	21.0	3.5	4.0
DS/ER25-4	P2780530	21.0	4.0	4.0
DS/ER25-4.5	P2780531	21.0	4.5	4.0
DS/ER25-5	P2780532	21.0	5.0	4.0
DS/ER25-5.5	P2780533	21.0	5.5	4.0
DS/ER25-6	P2780534	21.0	6.0	4.0
DS/ER25-6.5	P2780535	21.0	6.5	4.0
DS/ER25-7	P2780536	21.0	7.0	4.0
DS/ER25-7.5	P2780537	21.0	7.5	4.0
DS/ER25-8	P2780538	21.0	8.0	4.0
DS/ER25-8.5	P2780539	21.0	8.5	4.0
DS/ER25-9	P2780540	21.0	9.0	4.0
DS/ER25-9.5	P2780541	21.0	9.5	4.0
DS/ER25-10	P2780542	21.0	10.0	4.0
DS/ER25-10.5	P2780543	21.0	10.5	4.0
DS/ER25-11	P2780544	21.0	11.0	4.0
DS/ER25-11.5	P2780545	21.0	11.5	4.0
DS/ER25-12	P2780546	21.0	12.0	4.0
DS/ER25-12.5	P2780547	21.0	12.5	4.0
DS/ER25-13	P2780548	21.0	13.0	4.0
DS/ER25-13.5	P2780549	21.0	13.5	4.0
DS/ER25-14	P2780550	21.0	14.0	4.0
DS/ER25-14.5	P2780551	21.0	14.5	4.0

Unit : mm

MODEL No.	EDP No.	Dia.	INNER DIA. (Step : 0.5mm)	THICKNESS
DS/ER25-15	P2780552	21.0	15.0	4.0
DS/ER25-15.5	P2780553	21.0	15.5	4.0
DS/ER25-16	P2780554	21.0	16.0	4.0
DS/ER32-3	P2780555	27.0	3.0	4.0
DS/ER32-4	P2780556	27.0	4.0	4.0
DS/ER32-5	P2780557	27.0	5.0	4.0
DS/ER32-6	P2780558	27.0	6.0	4.0
DS/ER32-7	P2780559	27.0	7.0	4.0
DS/ER32-8	P2780560	27.0	8.0	4.0
DS/ER32-9	P2780561	27.0	9.0	4.0
DS/ER32-10	P2780562	27.0	10.0	4.0
DS/ER32-10.5	P2780563	27.0	10.5	4.0
DS/ER32-11	P2780564	27.0	11.0	4.0
DS/ER32-11.5	P2780565	27.0	11.5	4.0
DS/ER32-12	P2780566	27.0	12.0	4.0
DS/ER32-12.5	P2780567	27.0	12.5	4.0
DS/ER32-13	P2780568	27.0	13.0	4.0
DS/ER32-13.5	P2780569	27.0	13.5	4.0
DS/ER32-14	P2780570	27.0	14.0	4.0
DS/ER32-14.5	P2780571	27.0	14.5	4.0
DS/ER32-15	P2780572	27.0	15.0	4.0
DS/ER32-16	P2780573	27.0	16.0	4.0
DS/ER32-17	P2780574	27.0	17.0	4.0
DS/ER32-18	P2780575	27.0	18.0	4.0
DS/ER32-19	P2780576	27.0	19.0	4.0
DS/ER32-20	P2780577	27.0	20.0	4.0
DS/ER40-3	P2780578	33.5	3.0	4.0
DS/ER40-4	P2780579	33.5	4.0	4.0
DS/ER40-5	P2780580	33.5	5.0	4.0
DS/ER40-6	P2780581	33.5	6.0	4.0
DS/ER40-7	P2780582	33.5	7.0	4.0
DS/ER40-8	P2780583	33.5	8.0	4.0
DS/ER40-9	P2780584	33.5	9.0	4.0
DS/ER40-10	P2780585	33.5	10.0	4.0
DS/ER40-11	P2780586	33.5	11.0	4.0
DS/ER40-12	P2780587	33.5	12.0	4.0
DS/ER40-13	P2780588	33.5	13.0	4.0
DS/ER40-14	P2780589	33.5	14.0	4.0
DS/ER40-15	P2780590	33.5	15.0	4.0
DS/ER40-16	P2780591	33.5	16.0	4.0
DS/ER40-17	P2780592	33.5	17.0	4.0
DS/ER40-18	P2780593	33.5	18.0	4.0
DS/ER40-19	P2780594	33.5	19.0	4.0
DS/ER40-20	P2780595	33.5	20.0	4.0
DS/ER40-21	P2780596	33.5	21.0	4.0
DS/ER40-22	P2780597	33.5	22.0	4.0
DS/ER40-23	P2780598	33.5	23.0	4.0
DS/ER40-24	P2780599	33.5	24.0	4.0
DS/ER40-25	P2780600	33.5	25.0	4.0
DS/ER40-26	P2780601	33.5	26.0	4.0

RECOMMENDED CUTTING CONDITIONS

ISO	VDI 3323	Material Description	HB	HRc	TTS31,TTS32	TTS33,TTS34	TKS35,TKS36	TTS37,TTS38	TTS39
					Vc (m/min)				
P	1	Non-alloy steel	125		41-46	41-46	41-46	41-46	30-35
	2		190	13	41-46	41-46	41-46	41-46	41-46
	3		250	25	35-40	35-40	35-40	35-40	35-40
	4		270	28	28-33	28-33	28-33	28-33	28-33
	5		300	32					
	6		180	10	28-33	28-33	28-33	28-33	28-33
	7		275	29	28-33	28-33	28-33	28-33	28-33
M	12	Stainless steel	200	15	18-23	18-23		18-23	18-23
	13		240	23	13-18	13-18		13-18	13-18
	14		180	10	10-14	10-14		10-14	10-14
K	15	Grey cast iron	180	10	28-33	28-33	28-33		
	16		260	26			28-33		
	17	Nodular cast iron	160	3	28-33	28-33	28-33		
	18		250	25			28-33		
	19	Malleable cast iron	130				28-33		
20	230		21			28-33			
N	21	Aluminum-wrought alloy	60				28-33	28-33	
	22		100			28-33	28-33		
	23	Aluminum-cast, alloyed	75		41-46	41-46	30-35	41-46	41-46
	24		90		41-46	41-46	30-35	41-46	41-46
	25		130		30-35	30-35	30-35	30-35	30-35
	26	Copper and Copper Alloys (Bronze / Brass)	110		45-50	45-50			
	27		90						
	28		100		25-30	25-30		25-30	25-30

ISO	VDI 3323	Material Description	HB	HRc	TTS41-IC	TTS42-RCP	TKS43-IC	TKS44-RCP	TTS45-RCP
					Vc (m/min)				
P	1	Non-alloy steel	125		41-57	41-57	41-57	41-57	41-57
	2		190	13	41-57	41-57	41-57	41-57	41-57
	3		250	25	35-50	35-50	35-50	35-50	35-50
	4		270	28	28-41	28-41	28-41	28-41	28-41
	5		300	32					
	6		180	10	28-41	28-41	28-41	28-41	28-41
	7		275	29	28-41	28-41	28-41	28-41	28-41
M	12	Stainless steel	200	15	18-28	18-28			18-28
	13		240	23	13-22	13-22			13-22
	14		180	10	10-17	10-17			10-17
K	15	Grey cast iron	180	10	28-41	28-41	28-41	28-41	
	16		260	26			28-41	28-41	
	17	Nodular cast iron	160	3	28-41	28-41	28-41	28-41	
	18		250	25			28-41	28-41	
	19	Malleable cast iron	130				28-41	28-41	
20	230		21			28-41	28-41		
N	21	Aluminum-wrought alloy	60						28-41
	22		100						28-41
	23	Aluminum-cast, alloyed	75		41-57	41-57	30-43	30-43	41-57
	24		90		41-57	41-57	30-43	30-43	41-57
	25		130		30-43	30-43	30-43	30-43	30-43
	26	Copper and Copper Alloys (Bronze / Brass)	110		45-62	45-62			
	27		90						
	28		100		25-37	25-37			25-37

TROUBLE SHOOTING GUIDE

Specific Problem	Cause	Solution
Dimensional Accuracy		
Oversize Pitch Diameter	Incorrect Tap	1. Use proper limits of taps 2. Use longer chamfered taps
	Chip Packing	1. Use spiral point or spiral fluted taps 2. Reduce number of flutes to provide extra chip room 3. Use larger hole size 4. If tapping a hole, allow deeper hole where applicable or shorten the thread length of the parts 5. Use proper lubricant
	Galling	1. Apply proper surface treatment such as Hardslick or chrome 2. Use proper cutting lubricant 3. Reduce tapping speed 4. Use proper cutting angle in accordance with material being tapped 5. Use large hole size
	Operating Conditions	1. Apply proper tapping speed 2. Correct alignment of tap and drill hole 3. Free cutting either tap or workpiece 4. Use proper tapping speed to avoid torn or rough threads 5. Use lead screw tapper 6. Use proper tapping machine with suitable power 7. Avoid misalignment of the tap and drill hole from loose spindle or worn holder
	Tool Condition	1. Obtain proper indexing angle for the flutes at the cutting edge 2. Grind proper cutting angle and chamfer angle 3. Avoid too narrow a land width 4. Remove burrs from regrinding
Oversize Internal Diameter	Hole Size	1. Use minimum hole size 2. Avoid tapered hole 3. Use proper chamfered taps
	Galling	1. Galling solutions 1 through 4 above can be applied to this specific problem
Undersize Pitch Diameter	Incorrect Tap	1. Use oversize taps 2. Apply proper chamfer angle 3. Increase cutting angle
	Damaged Thread	1. Use proper reversing speed to avoid damaging tapped thread on the way out of the hole
	Left-over Chips	1. Increase cutting performance to avoid any left over chips in the hole 2. Remove left over chips from the hole for gage checking
Undersize Internal Diameter	Hole Size	1. Use maximum drill size
Breakage	Incorrect Tap Selection	1. Avoid chip packing in the flutes or on the bottom of the hole Use spiral pointed or spiral fluted taps or fluteless taps 2. Apply correct surface treatment such as Hardslick or bright
	Excessive Tapping Torque	1. Use larger drill size 2. Try to shorten thread length 3. Increase cutting angle 4. Apply a tap with more thread relief and reduced land width 5. Apply correct surface treatment such as Hardslick

TROUBLE SHOOTING GUIDE

Specific Problem	Cause	Solution
Dimensional Accuracy		
Breakage	Operating Conditions	1. Reduce tapping speed 2. Avoid misalignment between tap and the hole and tapered hole 3. Use floating type of tapping holder 4. Use tapping holder with torque adjustment 5. Avoid hitting bottom of the hole with tap
	Tool Condition	1. Do not grind the bottom of the flute 2. Avoid too narrow a land width 3. Remove all worn sections when regrinding the flutes 4. Regrind tool more frequently
Chipping	Incorrect Tap Selection	1. Reduce cutting angle 2. Use a different kind of high-speed steel tap 3. Reduce hardness of the tap 4. Increase chamfer length 5. Avoid chip packing in the flutes or in the bottom of the hole by using spiral fluted or spiral pointed taps
	Operating Conditions	1. Reduce tapping speed 2. Avoid misalignment between tap and hole 3. Avoid sudden return of reverse in blind hole tapping 4. Avoid galling 5. Use larger hole size
Wear	Incorrect Tap Selection	1. Apply specially designed tap for tapping heat treated material 2. Change to a type of high-speed steel tap that contains vanadium 3. Apply special surface treatment such as TiCN, TiAlN or Hardslick 4. Increase chamfer length
	Operating Conditions	1. Reduce tapping speed 2. Apply proper cutting lubricants 3. Avoid work hardened hole 4. Use larger hole size
	Tool Condition	1. Grind proper cutting angle 2. Avoid hardness reduction from grinding process
Torn or Rough Thread	Chamfer Too Short	1. Increase chamfer length
	Wrong Cutting Angle	1. Apply proper cutting angle
	Galling	1. Use thread relieved taps 2. Reduce land width 3. Apply surface treatment such as Hardslick or chrome 4. Use proper cutting lubricant 5. Reduce tapping speed 6. Use larger hole size 7. Obtain proper alignment between tap and work
	Chip Packing	1. Use spiral pointed or spiral fluted taps 2. Use larger drill size
Chattering on Tapped Thread	Tool Free Cutting	1. Reduce cutting angle 2. Reduce amount of thread relief
	Tool Condition	1. Avoid too narrow land width 2. Do not grind the bottom of the flute

TAP TOLERANCES

► Tolerance classes of taps and tolerance positions for screw threads as per Metric ISO Standard.

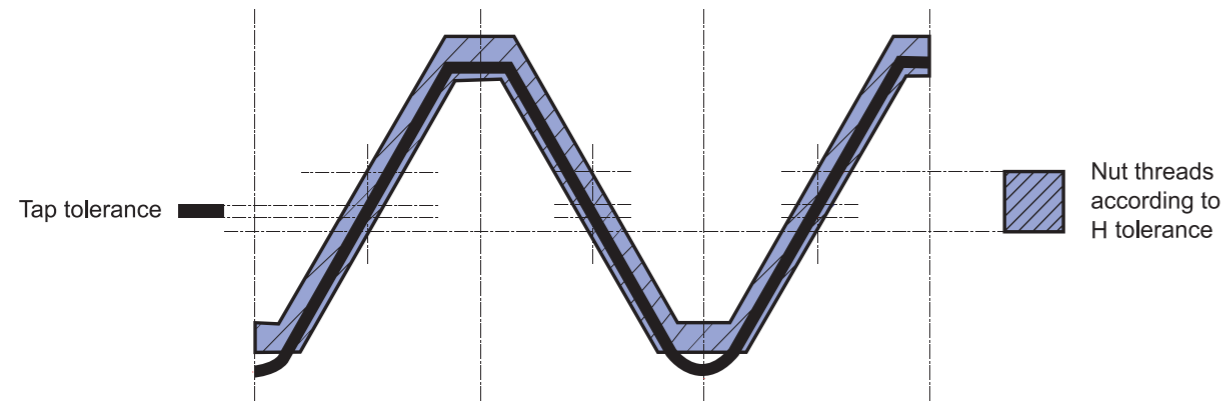

Nut thread Positioning of H tolerance	Tolerance Classes for Taps	Nut thread Positioning of G tolerance
---	-------------------------------	---

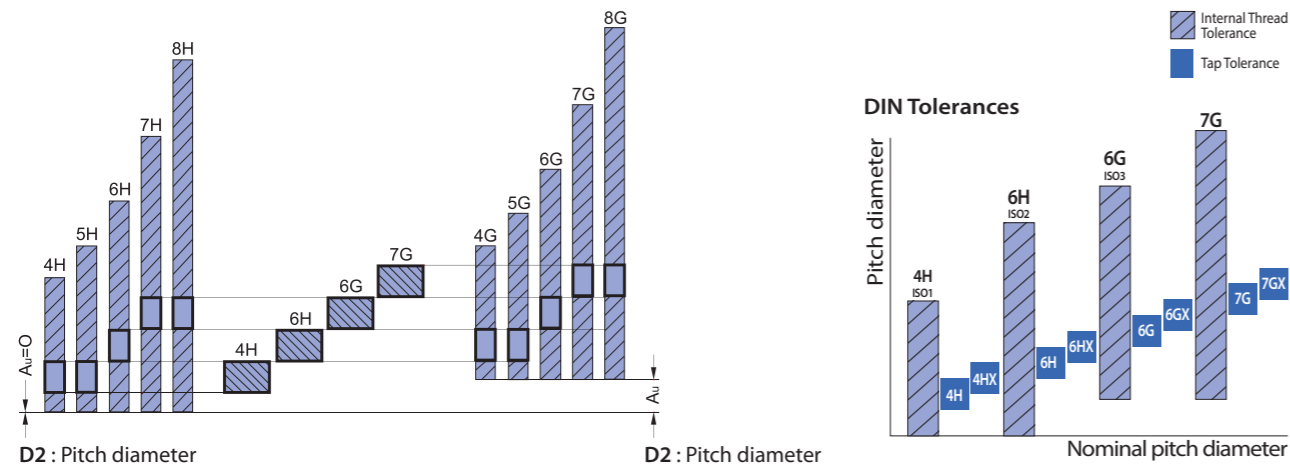

► Taps tolerances and recommended classes

Tap tolerance ISO	Tap tolerance DIN	Correct class to obtain Nut thread with tolerance				
ISO 1	4H	4H	5H			
ISO 2	6H	4G	5G	6H		
ISO 3	6G			6G	7H	8H
	7G				7G	8G

MEMO

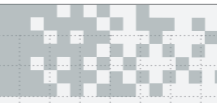

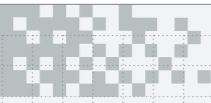

HIGH QUALITY PRODUCTS and ON TIME DELIVERY for WORLD-WIDE CUSTOMERS

Since 1982, YG-1 has been committed to quality, innovation and the unique customer experience. Our performance and experience have granted YG-1 the global impression of one of the leading manufacturers of high quality cutting tool solutions. This global footprint expands over 75 countries, with international logistic centers, pledging to our customers to give the best service available today - and tomorrow.

EUROPE

BELGIUM	FINLAND	ITALY	PORTUGAL	SLOVENIA	THE NETHERLANDS
CROATIA	FRANCE	LITHUANIA	ROMANIA	SPAIN	TÜRKIYE
CZECH REPUBLIC	GERMANY	NORWAY	SWEDEN	UNITED KINGDOM	DENMARK
HUNGARY	POLAND	SERBIA	SWITZERLAND	AUSTRIA	GREECE
ALBANIA	BOSNIA AND HERZEGOVINA	UKRAINE	UZBEKISTAN	BULGARIA	
ESTONIA					

ASIA PACIFIC

AUSTRALIA	INDONESIA	MALAYSIA	SOUTH KOREA	VIETNAM
CHINA	ISRAEL	PAKISTAN	TAIWAN	
HONG KONG	JAPAN	PHILIPPINES	THAILAND	
INDIA	SAUDI ARABIA	SINGAPORE	UNITED ARAB EMIRATES	

AMERICAS

BRAZIL	CANADA	COLOMBIA	MEXICO	UNITED STATES
--------	--------	----------	--------	---------------

AFRICA

EGYPT	SOUTH AFRICA
-------	--------------

YG-1 CO., LTD.

* For the more information on sales network, please contact the head office as below;

HEAD OFFICE

13-40, Songdogwahak-ro 16beon-gil, Yeonsu-gu, Incheon 21984, South Korea

Phone: +82-32-526-0909

<https://www.yg1.kr>

E-mail: yg1@yg1.kr

YG-1 CO., LTD.

HEAD OFFICE

13-40, Songdogwahak-ro 16beon-gil,
Yeonsu-gu, Incheon 21984, South Korea

Notice YG-1 Global head office is relocating from December 2020 to a new address as above;

Phone: +82-32-526-0909

www.yg1.kr

E-mail: yg1@yg1.kr

Note The information is provided for reference only. Tool specifications are subject to change without prior notice.
Although we endeavor to supply accurate and timely information, there can be no guarantee to cover every particular application.
YG-1 or publishers are not liable for any damage for use of the information.



Search 'YG-1' on social media outlets



세계일류상품

YG1YESY2311002